



Environmental Systems

Keith Products, Inc.
4554 Claire Chennault
Dallas, TX 75248
Phone (214) 407-1234
Fax (214) 407-1571

SERVICE MANUAL

TR-128

VAPOR CYCLE AIR CONDITIONING SYSTEMS

September 1983

Rev. A, 3-2-84
Rev. B, 9-30-86
Rev. C, 4-27-87

**AIR CONDITIONER SERVICE AND MAINTENANCE
MANUAL**

TABLE OF CONTENTS

| | |
|---|------------|
| A. <u>SYSTEM DESCRIPTION</u> | A-1 |
| B. <u>GENERAL SERVICE</u> | B-1 |
| REFRIGERANT R-12 | B-1 |
| COMPRESSOR OIL | B-1 |
| GENERAL SERVICE INSTRUCTIONS | B-1 |
| SAFETY PRECAUTIONS | B-1 |
| C. <u>EVACUATING AND CHARGING THE SYSTEM</u> | C-1 |
| TOOLS REQUIRED | C-1 |
| HANDLING MANIFOLD GAUGE | C-1 |
| HANDLING SERVICE VALVE | C-4 |
| HANDLING CHARGING STAND | C-5 |
| HANDLING CAN TAP | C-6 |
| DISCHARGING SYSTEM | C-8 |
| COMPRESSOR OIL LEVEL CHECK | C-8 |
| EVACUATING SYSTEM | C-10 |
| CHARGING REFRIGERANT | C-12 |
| REFRIGERANT LEVEL CHECK | C-17 |
| REFRIGERANT LEAKS | C-18 |
| D. <u>SERVICE PROCEDURES</u> | D-1 |
| GENERAL CLEANING, INSPECTION, AND REPAIR | D-1 |
| PRECAUTIONS FOR REMOVAL AND INSTALLATION | D-1 |
| FLUSH PROCEDURE | D-2 |
| REFRIGERANT LINES | D-3 |
| COMPRESSOR | D-4 |
| Removal | D-4 |
| Installation | D-4 |

TABLE OF CONTENTS (Cont'd.)

| | | |
|----|--|------|
| D. | <u>SERVICE PROCEDURES (Cont'd.)</u> | |
| | CONDENSER AND EVAPORATOR | D-11 |
| | Removal | D-11 |
| | Inspection | D-11 |
| | RECEIVER DRYER | D-11 |
| | Removal And Installation | D-12 |
| | Inspection | D-12 |
| E. | <u>TROUBLE DIAGNOSES AND CORRECTIONS</u> | E-1 |
| | AIR CONDITIONER DIAGNOSES | E-1 |
| | PERFORMANCE TEST/DIAGNOSES | E-3 |
| | COMPRESSOR/CLUTCH DIAGNOSES | E-8 |
| F. | <u>COMPRESSOR OVERHAUL PROCEDURES</u> | F-1 |
| | GENERAL | F-1 |
| | TOOLS REQUIRED | F-1 |
| | COMPRESSOR TYPES | F-2 |
| | DISASSEMBLY PROCEDURES | F-4 |
| | ASSEMBLY PROCEDURES | F-8 |

A. SYSTEM DESCRIPTION

If you were to paint your finger with alcohol, your finger would feel cold. This is because the liquid alcohol takes heat away from your finger while it evaporates. If a quickly evaporating liquid such as alcohol is placed in a container inside a box, the temperature inside the box will drop. This is because the alcohol is evaporated absorbing the heat from the air inside the box. If the gaseous alcohol is collected and cooled with cold water, it will be changed back into a liquid by absorption of its heat by the cold water.

The vapor cycle air conditioner operates on this principle. The liquid used is the refrigerant R-12. The heat inside the cabin is absorbed by changing the refrigerant from a liquid to a gas and then dissipated to the outside by the changing of the refrigerant from a gas back to a liquid.

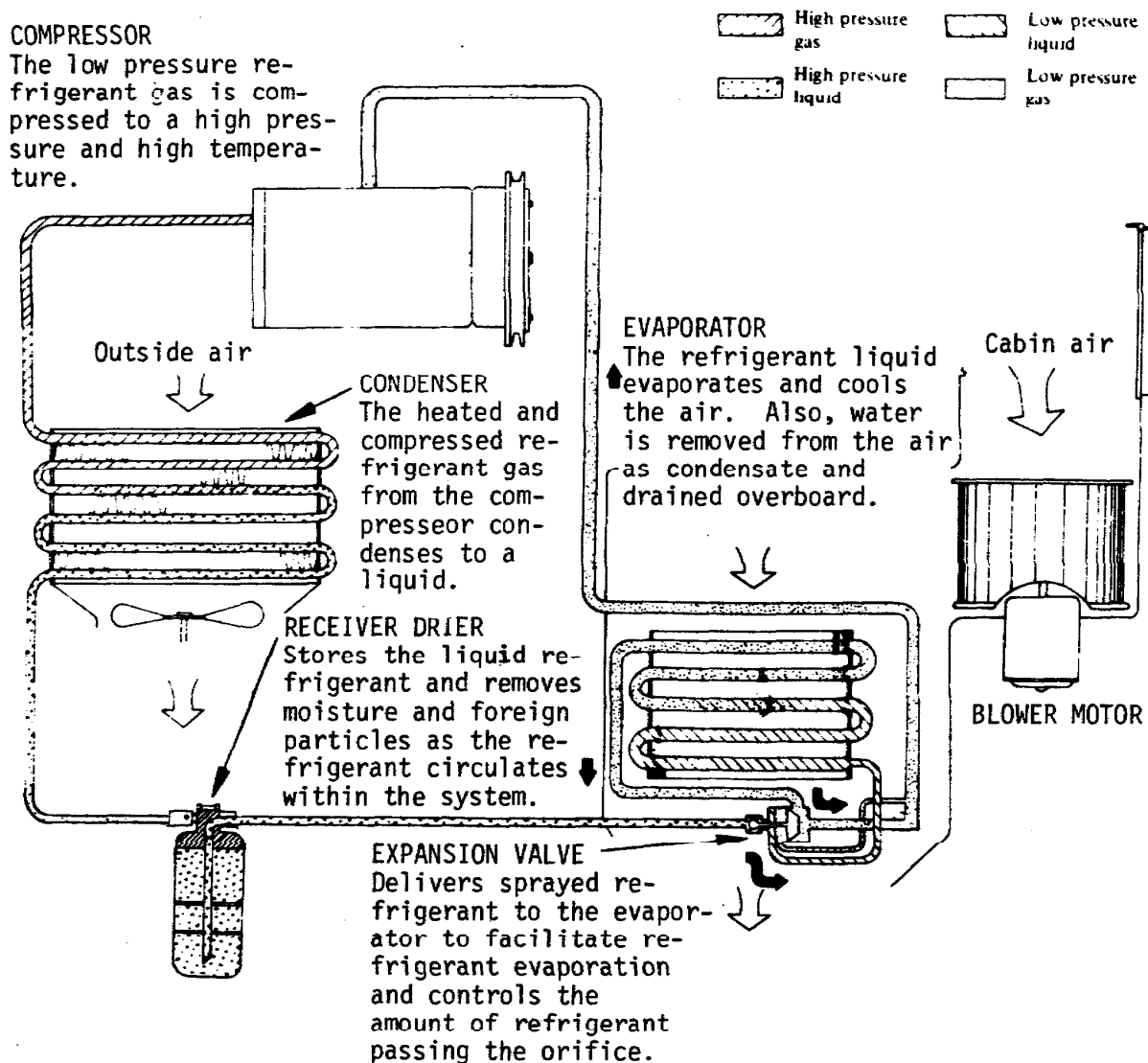

B-1

B. GENERAL SERVICE

Refrigerant R-12

The refrigerant used in the air conditioner is generally called "Refrigerant-12 (R-12)". No other refrigerant than the above refrigerant should be used.

NOTE: Exercise care when handling refrigerant as it is stored under high pressure.

COMPRESSOR OIL

The "SUNISO 5GS" refrigeration lubricant or equivalent should be used to ensure successful compressor operation. Use of oils other than recommended or mixing of the oil with other oils would cause chemical reaction or lead to lowered viscosity or deficient lubrication. Equivalent oils: Texaco Capella E, Virginia Chemicals 500 viscosity.

GENERAL SERVICE INSTRUCTIONS

The air conditioner system will be seriously affected if dirt, water, or air enters the system. Be sure to observe the following:

1. Always keep the working place clean and dry and free from dirt and dust. Wipe water off from the line fittings with a clean cloth before disconnecting.
2. Have all necessary tools in preparation beforehand and have tools clean and dry.
3. Insert plugs into any disconnected refrigerant lines.
4. Avoid contamination of compressor oil.

For details refer to each description in this manual.

SAFETY PRECAUTIONS

The refrigerant used in the air conditioning system is R-12. This refrigerant is non-explosive, non-inflammable, non-corrosive, has practically no odor, and is heavier than air. Although R-12 is classified as a safe refrigerant, certain precautions must be observed to protect parts involved and the person working on the unit.

1. Liquid R-12, at normal atmospheric pressure and temperature, evaporates so quickly that it tends to freeze anything that it contacts. Care must be taken to prevent any liquid refrigerant from coming in contact with the skin and especially the eyes. R-12 is readily absorbed by most types of oil. Therefore, it is recommended that a bottle of clean mineral oil and weak solution of boric acid be kept nearby when servicing the refrigerant system.

GENERAL SERVICE (Cont'd.)

SAFETY PRECAUTIONS (Cont'd.)

2. Always wear safety goggles when servicing any part of the refrigerant system.
3. Should any liquid refrigerant get into the eyes, use a few drips of mineral oil to wash them out, then use a weak solution of boric acid to wash eyes, and seek aid from a doctor immediately even though the irritation has ceased.
4. The refrigerant gas is odorless and colorless and breathing may become difficult due to the lack of oxygen. Since the refrigerant gas is heavier than air and will lay close to the floor, be especially careful when handling it in small, confined spaces.
5. To avoid explosion, never weld, use a blow torch, solder, steam clean, bake aircraft finish, or use excessive amounts of heat on, or in, the immediate area of any part of the air conditioning system, or refrigerant supply tank, full or empty, while they are closed to atmosphere. Although R-12 gas, under normal conditions, is non-poisonous, the discharge of refrigerant near an open flame can produce a very poisonous gas (PHOSGENE GAS). This gas will also attack all bright metal surfaces. This poisonous gas is also generated in small quantities when a flame-type leak detector is used.
6. The refrigerant service container has a safe strength. However, if handled incorrectly, it will explode. Therefore, always follow the instructions on the label. In particular, never store it in a hot location (above 126° F., 52° C.) or drop it from a great height.

The above precautions are essential in handling of Refrigerant-12, and their strict observation requires sufficient training. Therefore, it is of first importance that any personnel other than a well trained serviceman should not be allowed to handle the refrigerant.

C. EVACUATING AND CHARGING SYSTEM

During servicing, use caution to keep air from getting into refrigerant. When air enters the system, all refrigerant must be evacuated from system prior to charging new refrigerant. Air in refrigerant has the following deleterious effects:

1. Since the condensation temperature of the air is extremely low, the air will not be condensed when refrigerant gas is condensed in the condenser, and the air will thus remain in gaseous form. Consequently, the effective thermal transmission area of the condenser will be reduced and the amount of refrigerant gas to be condensed will be reduced. The pressure rise will become proportional to the volume of the air in the system.
2. When air and refrigerant are mixed in the system, a chemical reaction will occur and hydrochloric acid; which will adversely affect the aluminum, copper, iron, and other materials in the system; may be generated.

TOOLS REQUIRED

1. **MANIFOLD GAUGE SET** - consists of a manifold with three fittings to which refrigerant service hoses are attached; two hand valves with O-ring type seals; and two gauges, one for the low side and the other for the high side. The low side gauge is a compound gauge, i.e., capable of reading negative pressures down to 30 inches of mercury (below atmospheric) and positive pressures up to about 60 p.s.i.g. The high side gauge should have a range from zero to 600 p.s.i.g.
2. **CHARGING HOSES**, three are required.
3. **VACUUM PUMP** Must be capable of pulling about 29.62 inches of mercury, gauge.
4. **REFRIGERANT SOURCE.** R-12 is available in one or 2 1/2 pound cans, 10 or 12 pound disposable cylinders, or in larger returnable cylinders. However, the preferred way to handle refrigerant is with a charging stand or cart. These devices are equipped with graduations to facilitate the dispensing of R-12 by weight. They also have built-in electric heaters to help force refrigerant into the air conditioning system. This feature is a near-necessity when the system is being charged without the compressor running. To accomplish this kind of charging with the R-12 cans would require the warming of the cans by a hot water bath. The Robinair Dial-A-Charge is a charging stand produced by the Robinair Manufacturing Corp. of Montpelier, Ohio. The charging stand pictured is a Kent Moore J23500. These are just two examples of the types available. This is not to be construed as an endorsement of any particular models or manufacturers.

C. EVACUATING AND CHARGING SYSTEM (cont'd)

TOOLS REQUIRED (cont'd)

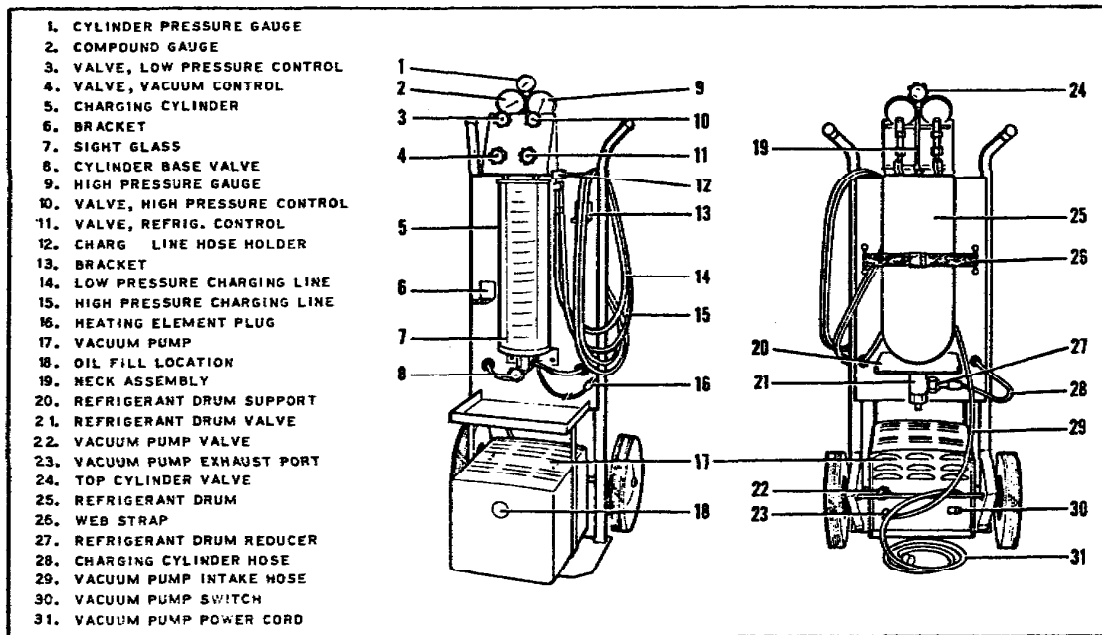

Charging Stand

C. EVACUATING AND CHARGING SYSTEM (cont'd)

TOOLS REQUIRED (cont'd)

5. LEAK DETECTOR. The use of the electronic leak detector General Electric Model H-10 is recommended; however, if the H-10 is not available, leak detector solution conforming to MIL-L-25567 can be used to check each fitting, hose connection, and air conditioning component.

CAUTION: The use of a flame-type leak detector is not recommended for use on aircraft because of fire and health hazard.

6. COMPRESSOR OIL DIP STICK. See Figure.

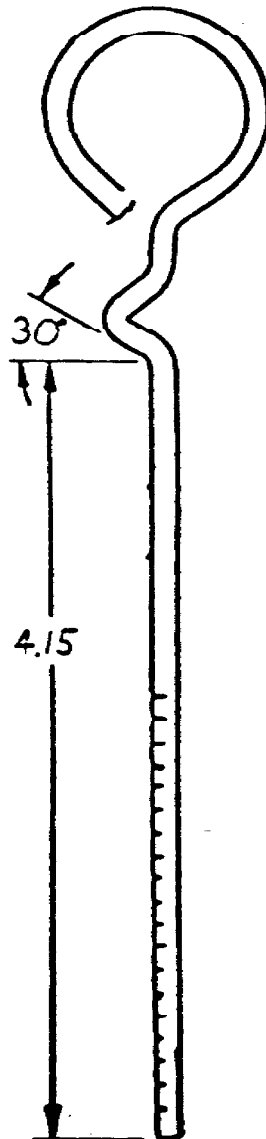

OIL DIP STICK
1/8" INCREMENTS

7. WET BULB/DRY BULB THERMOMETER
8. R-12 CAN TAP. Only needed when using small disposable refrigerant can.

C. EVACUATING AND CHARGING THE SYSTEM (cont'd)

HANDLING MANIFOLD GAUGE

The pressure at the high and low sides of the system should be measured when evacuating and charging refrigerant and when diagnosing trouble in the system. The manifold gauge is used for these purposes. A manifold gauge has two pressure gauges; a low pressure gauge and a high pressure gauge. These gauges are connected to the high and low side service valves of the system through flexible charging hoses. The construction of the manifold gauge is shown in the figure below.

When the valve stem is fully screwed in, the valve is front-seated and the valve path and the center path are blocked. When the valve stem is backed off, the paths are opened.

Connection to service valve:

1. Fully close both valves of the manifold gauge. Connect the high and low pressure charging hoses to the manifold gauge.
2. Remove the caps from the service valves. Connect the high- and low- pressure charging hoses to the service valves in the system. A small amount of refrigerant will normally escape during attachment of the manifold lines to the charging ports.
3. Next, loosen the connection fitting of the charging hose at the manifold gauge side for 2 to 3 seconds to purge any air inside the charging hoses by the pressurized gas in the system.

Disconnection from service valve:

1. Fully close both valves of the manifold gauge.
2. Disconnect two charging hoses from the service valves. At this time, the gas will be discharged from the system until the check valve is closed. Therefore, disconnect the hose quickly.

WARNING: WORK WITH FINGERS PROTECTED WITH CLOTH AGAINST FROSTBITE BY REFRIGERANT.

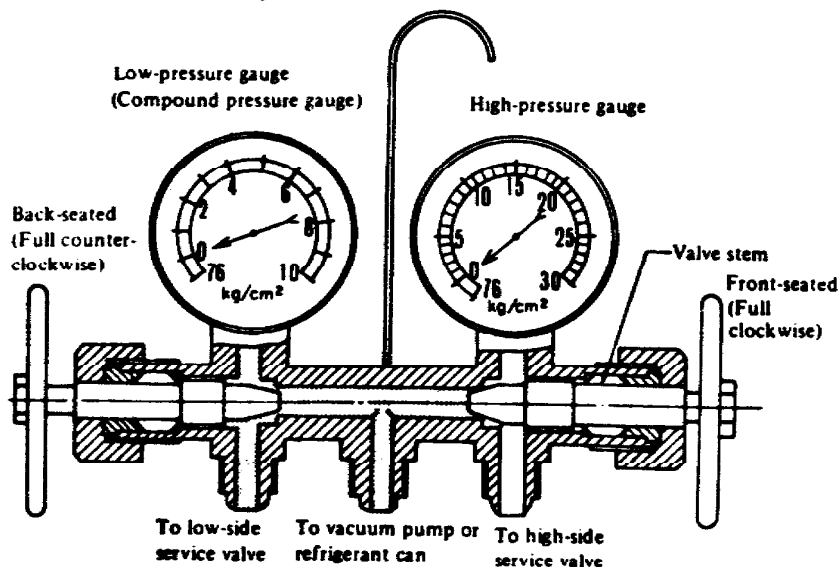

C. EVACUATING AND CHARGING THE SYSTEM (cont'd)

HANDLING SERVICE VALVE

An automatic check valve is built into the service valve. When this valve presses against the connection fitting, that is, when the charging hose is connected to the service valve, the valve is open. When the charging hose is disconnected, the valve is closed automatically. Always observe the following usage precautions:

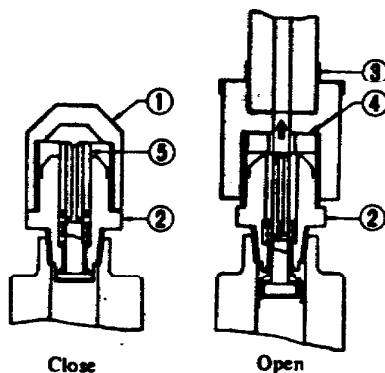

- | | |
|--------------------|----------------|
| 1. Cap | 4. Gasket |
| 2. Servicing valve | 5. Check valve |
| 3. Charging hose | |

1. Always install the valve cap after using the service valve. When high speed operation is performed without a valve cap, a negative pressure will gradually build up at the low pressure side of the system and air may be sucked in. In addition, dirt and dust will easily enter the valve resulting in foreign matter entering the system.

CAUTION: DO NOT OVER-TIGHTEN VALVE CAP.

2. The check valve will be half opened during connection and disconnection of the charging hoses and refrigerant will be forcefully discharged. Therefore, connect and disconnect charging hoses quickly while pressing the flare nut of the charging hose against the service valve.

WARNING: WORK WITH FINGERS PROTECTED WITH CLOTH AGAINST FROSTBITE BY REFRIGERANT.

3. Since close contact between the thread of the valve cap and the thread of the service valve will prevent gas leakage, keep these areas clean and free of scratches and damage.
4. Since the gasket of the charging hose may fall out during use, always check to insure the presence of the gasket prior to installing charging hose.

HANDLING CHARGING STAND

Follow manufacturer's instructions.

C. EVACUATING AND CHARGING SYSTEM (cont'd)

HANDLING CAN TAP

A wide variety of can taps is available. The following procedures apply to conventional can taps.

For the correct usage, refer to the manufacturer's instructions.

1. Connect the charging hose to the center fitting of the manifold gauge. At this time, confirm that both stems are fully turned in (front seated).
2. Turn the can tap handle fully counterclockwise so that the needle is pulled up.
3. Attach the can tap to the refrigerant can firmly.
4. Turn the can tap handle fully clockwise to make a hole in the refrigerant can.
5. Turn the handle fully counterclockwise to raise the needle. Refrigerant gas will flow up to the center fitting of the manifold gauge.
6. Loosen the connection at the center fitting of the manifold gauge for a few seconds to purge air inside the charging hose.

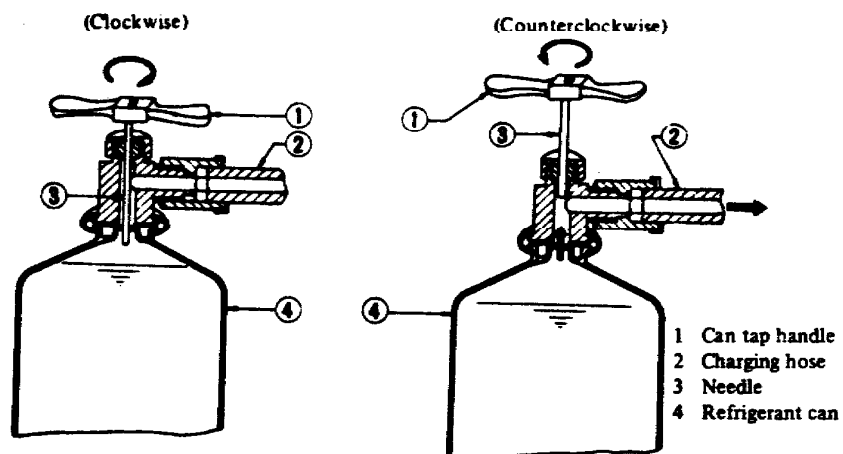

C. EVACUATING AND CHARGING SYSTEM (cont'd)

HANDLING CAN TAP (cont'd)

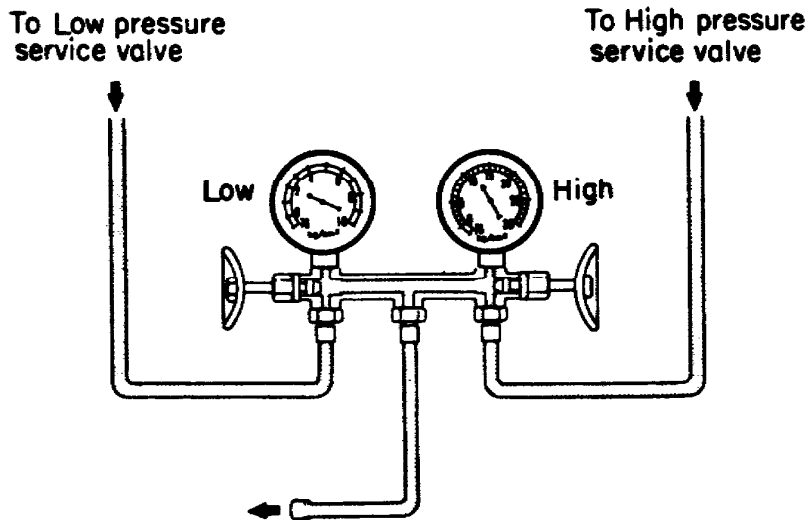
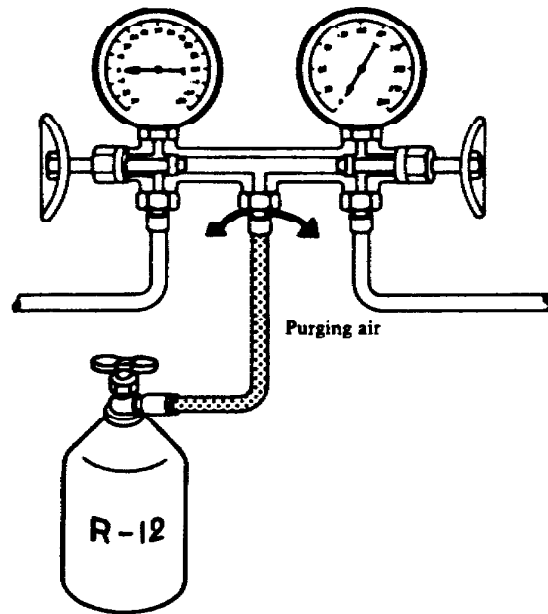

C. EVACUATING AND CHARGING SYSTEM (Cont'd.)

DISCHARGING SYSTEM

The pressurized refrigerant gas inside the system must be discharged to a pressure approaching atmospheric pressure prior to evacuating the remaining refrigerant from the system. This operation should also be made to permit safe removal when replacing system components.

1. Close high- and low-pressure valves of the manifold gauge fully.
2. Connect the two charging hoses of the manifold gauge to their respective service valves.

WARNING: SECURELY CONNECT HIGH PRESSURE (DISCHARGE) SERVICE VALVE TO THAT OF MANIFOLD GAUGE WITH A HOSE; ALSO CONNECT LOW PRESSURE (SUCTION) SERVICE VALVE TO THAT OF MANIFOLD GAUGE.

3. Open both manifold gauge valves slightly and slowly discharge refrigerant from the system.

WARNING: PROTECT FINGERS WITH CLOTH AGAINST FROSTBITE BY REFRIGERANT WHEN CONNECTING THE CHARGING HOSE TO THE SERVICE VALVE OR DISCONNECTING IT THEREFROM.

Do not allow refrigerant to rush out. Otherwise, compressor oil will be discharged along with refrigerant.

COMPRESSOR OIL LEVEL CHECK

CAUTION: The system must be discharged PRIOR to the oil level check. See "DISCHARGING SYSTEM" for instructions.

- NOTES:**
1. It is not necessary to check the oil level as routine maintenance. However, should there be good reason to suspect an incorrect oil level or a system component is being replaced or it is specified in a diagnosis procedure to check the oil, follow the appropriate procedure below.
 2. Do not overcharge with oil as too much oil reduces system performance.
 3. Aluminum or steel powder in the oil is normal, during break-in, and does not reduce normal service life.

PROCEDURE FOR INITIAL COMPRESSOR INSTALLATION

NOTE: If the manufacturer has specified a predetermined oil charge for your specific system, follow the procedure specified in items 1 and 2 below. If no predetermined charge is given follow the procedure 1 through 5 below. This is required because a portion of the oil will be distributed to other system components.

C. EVACUATING AND CHARGING SYSTEM (Cont'd.)COMPRESSOR OIL LEVEL CHECK (Cont'd.)

1. Determine the mounting angle by positioning a angle protractor across the flat surfaces of the mounting ears.
2. Remove oil filler plug, rotate compressor to position the internal parts as shown below.
 - Comperssor mounted to the right (facing clutch) -Center the parts as they are moving to the rear of the compressor.
 - Compressor mounted to the left (facing clutch) -Center the parts as they are moving to the front of the compressor.

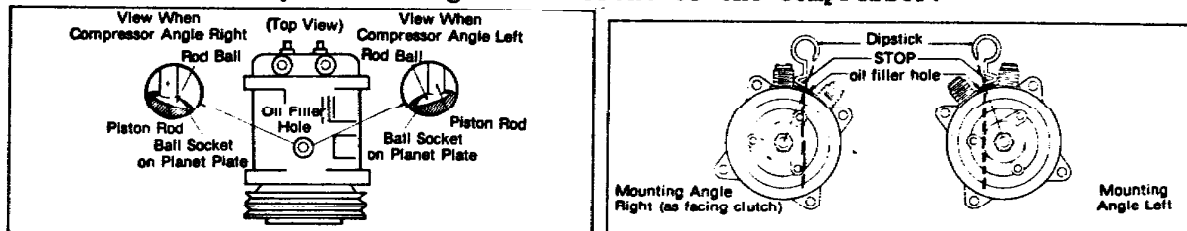

3. Insert dip stick (JBS63-1) to its stop position, remove and count increments of oil, use chart below to determine the correct oil for compressor mounting angle, and adjust as required.

ACCEPTABLE OIL LEVEL IN INCREMENTS ALL DASH #'s.

| Mounting Angle/ Degree | ES10505 | ES10006 | E10508 |
|---------------------------|---------|---------|--------|
| | JBS201 | JBS57 | E10508 |
| | JBS215 | JBS98 | JBS204 |
| | | JBS197 | JBS226 |
| 0 | 4-6 | 3-5 | 4-6 |
| 10 | 6-8 | 5-7 | 6-8 |
| 20 | 8-10 | 6-8 | 7-9 |
| 30 | 10-11 | 7-9 | 8-10 |
| 40 | 11-12 | 8-10 | 9-11 |
| 50 | 12-13 | 8-10 | 9-11 |
| 60 | 12-13 | 9-11 | 9-12 |
| 90 | 15-16 | 9-11 | 9-12 |

4. Reinstall oil filler plug (Torque 6-9 ft-lbs.) and operate system 10-15 minutes, discharge system, adjust oil level as above.

PROCEDURE FOR SUBSEQUENT OIL LEVEL CHECKS

1. Run the compressor for 10 minutes.
2. Recover all refrigerant from the system, being careful not to loose any oil.
3. Take dipstick reading and add or remove oil in one ounce increments to achieve the previously recorded amount.
4. Evacuate and recharge the system per section C of this manual.

C. EVACUATING AND CHARGING SYSTEM (cont'd)

EVACUATING THE SYSTEM

1. Connect high- and low-pressure charging hoses of manifold gauge to their respective service valves of system and discharge refrigerant from system. Refer to Discharging System.
2. When refrigerant has been discharged to a pressure approaching atmospheric pressure, connect center charging hose to a vacuum pump.
3. Close both valves of manifold gauge fully. Then start vacuum pump.
4. Open low-pressure valve and suck old refrigerant from system.
5. When low-pressure gauge reading has reached approximately 19.69 in Hg (500 mmHg, 66.7 kPa), slowly open high-pressure valve.

First step

To Low pressure
service valve

To High pressure
service valve

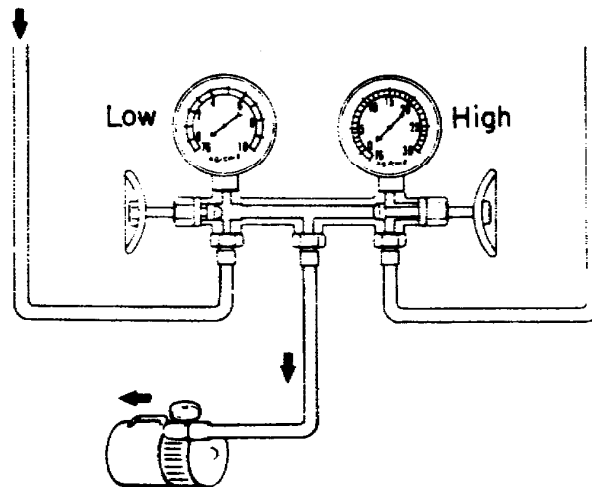

Second step

To Low pressure
service valve

To High pressure
service valve

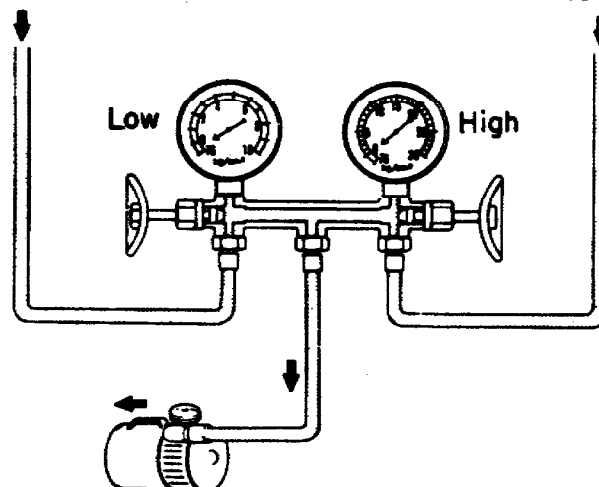

C. EVACUATING AND CHARGING SYSTEM (Cont'd.)

EVACUATING THE SYSTEM (Cont'd.)

6. When pressure inside system has dropped to 27.95 in Hg (710 mmHg, 94.6 kPa), continue to pull vacuum for 30 minutes. Periodically check for leaks by closing valves and verifying that the system is holding a vacuum.
 - a. The low-pressure gauge reads lower by 1 inHg (25.4 mmHg, 3.4 kPa) for every 1000 ft (300m) elevation. Perform evacuation according to the following table.

| ELEVATION ft (m) | VACUUM OF SYSTEM* inHg (mmHg, kPa) |
|---------------------|---------------------------------------|
| 0(0) | 28.0 (710,94.6) |
| 1000 (300) | 27.0 (685,91.3) |
| 2000 (600) | 26.0 (660,88.0) |
| 3000 (900) | 25.0 (635,84.6) |

*Values show reading of the low-pressure gauge.

- b. The rate of ascension of the low-pressure gauge should be less than 1 inHg (25.4 mmHg, 3.4 kPa) in five minutes.

If the pressure rises or the specified negative pressure can not be obtained, there is a leak in the system. In this case, immediately charge system with refrigerant and repair the leak as described in the following.

1. Charge system with a can of refrigerant (about 0.4 kg) (0.9 lb). Refer to Charging Refrigerant.
2. Check for refrigerant leakage with a leak detector. Repair any leakages found. Refer to Refrigerant leaks, this manual.
3. Discharge refrigerant again, and then evacuate system.

C. EVACUATING AND CHARGING SYSTEM (Cont'd.)

CHARGING REFRIGERANT

Since the charging procedure begins with the air conditioning system evacuated, the initial portion of the charge will be automatically drawn in by the system vacuum. However, once the pressure within the system has equalized with atmospheric pressure, the remainder of the charge must be forced into the system. This can be accomplished by either running the system, in which case the compressor will draw the refrigerant into the low-pressure line, or if the compressor cannot be run, by raising the temperature (and hence the pressure) of the R-12 in the charging can or cylinder.

Below is a pressure/temperature chart for R-12 for reference.

| TEMPERATURE-PRESSURE RELATION CHART (FOR REFRIGERANT 12) | | | | | | | | | |
|---|--------------|------------|--------------|------------|--------------|------------|--------------|------------|--------------|
| Temp F. | Press PSI | Temp F. | Press PSI | Temp F. | Press PSI | Temp F. | Press PSI | Temp F. | Press PSI |
| 0 | 9.1 | 35 | 32.5 | 60 | 57.7 | 85 | 91.7 | 110 | 136.0 |
| 2 | 10.1 | 36 | 33.4 | 61 | 58.9 | 86 | 93.2 | 111 | 138.0 |
| 4 | 11.2 | 37 | 34.3 | 62 | 60.0 | 87 | 94.8 | 112 | 140.1 |
| 6 | 12.3 | 38 | 35.1 | 63 | 61.3 | 88 | 96.4 | 113 | 142.1 |
| 8 | 13.4 | 39 | 36.0 | 64 | 62.5 | 89 | 98.0 | 114 | 144.2 |
| 10 | 14.6 | 40 | 36.9 | 65 | 63.7 | 90 | 99.6 | 115 | 146.3 |
| 12 | 15.8 | 41 | 37.9 | 66 | 64.9 | 91 | 101.3 | 116 | 148.4 |
| 14 | 17.1 | 42 | 38.8 | 67 | 66.2 | 92 | 103.0 | 117 | 151.2 |
| 16 | 18.3 | 43 | 39.7 | 68 | 67.5 | 93 | 104.6 | 118 | 152.7 |
| 18 | 19.7 | 44 | 40.7 | 69 | 68.8 | 94 | 106.3 | 119 | 154.9 |
| 20 | 21.0 | 45 | 41.7 | 70 | 70.1 | 95 | 108.1 | 120 | 157.1 |
| 21 | 21.7 | 46 | 42.6 | 71 | 71.4 | 96 | 109.8 | 121 | 159.3 |
| 22 | 22.4 | 47 | 43.6 | 72 | 72.8 | 97 | 111.5 | 122 | 161.5 |
| 23 | 23.1 | 48 | 44.6 | 73 | 74.2 | 98 | 113.3 | 123 | 163.8 |
| 24 | 23.8 | 49 | 45.6 | 74 | 75.5 | 99 | 115.1 | 124 | 166.1 |
| 25 | 24.6 | 50 | 46.6 | 75 | 76.9 | 100 | 116.9 | 125 | 168.4 |
| 26 | 25.3 | 51 | 47.8 | 76 | 78.3 | 101 | 118.8 | 126 | 170.7 |
| 27 | 26.1 | 52 | 48.7 | 77 | 79.2 | 102 | 120.6 | 127 | 173.1 |
| 28 | 26.8 | 53 | 49.8 | 78 | 81.8 | 103 | 122.4 | 128 | 175.4 |
| 29 | 27.6 | 54 | 50.9 | 79 | 82.5 | 104 | 124.3 | 129 | 177.8 |
| 30 | 28.4 | 55 | 52.0 | 80 | 84.0 | 105 | 126.2 | 130 | 182.2 |
| 31 | 29.2 | 56 | 53.1 | 81 | 85.5 | 106 | 128.1 | 131 | 182.6 |
| 32 | 30.0 | 57 | 55.4 | 82 | 87.0 | 107 | 130.0 | 132 | 185.1 |
| 33 | 30.9 | 58 | 56.6 | 83 | 88.5 | 108 | 132.1 | 133 | 187.6 |
| 34 | 31.7 | 59 | 57.1 | 84 | 90.1 | 109 | 135.1 | 134 | 190.1 |

C. EVACUATING AND CHARGING SYSTEM (Cont'd.)

CHARGING REFRIGERANT (Cont'd.)

1. Install the manifold gauge to the system. Refer to Handling Manifold Gauge.

WARNING: SECURELY CONNECT HIGH PRESSURE (DISCHARGE) SERVICE VALVE TO THAT OF MANIFOLD GAUGE WITH A HOSE; ALSO CONNECT LOW PRESSURE (SUCTION) SERVICE VALVE TO THAT OF MANIFOLD GAUGE.

CAUTION:

- A. Be sure to purge air from the high- and low-pressure charging hoses.
 - B. If air is mixed with refrigerant gas in the system, evacuation of the system should be performed. Refer to Evacuating System.
2. Attach the center charging hose of the manifold gauge to the refrigerant can through the can tap. Break the seal of the refrigerant can to allow the refrigerant to enter the manifold gauge. Loosen the charging hose at the center fitting of the manifold gauge and purge the air from the inside charging hose. Refer to Handling Can Tap.
 3. Open the high- and low- pressure valves of the manifold gauge and charge refrigerant into the system.

When the refrigerant charging speed is slow, immerse refrigerant can in water heated to a temperature of about 104° F. (40° C.) for a short time.

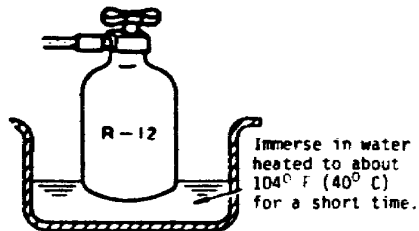

WARNING: UNDER NO CIRCUMSTANCES SHOULD THE REFRIGERANT BE WARMED IN WATER OVER 126° F. (52° C.). A BLOW TORCH OR STOVE MUST NEVER BE USED TO WARM THE CAN.

C. EVACUATING AND CHARGING SYSTEM (cont'd)

CHARGING REFRIGERANT (cont'd)

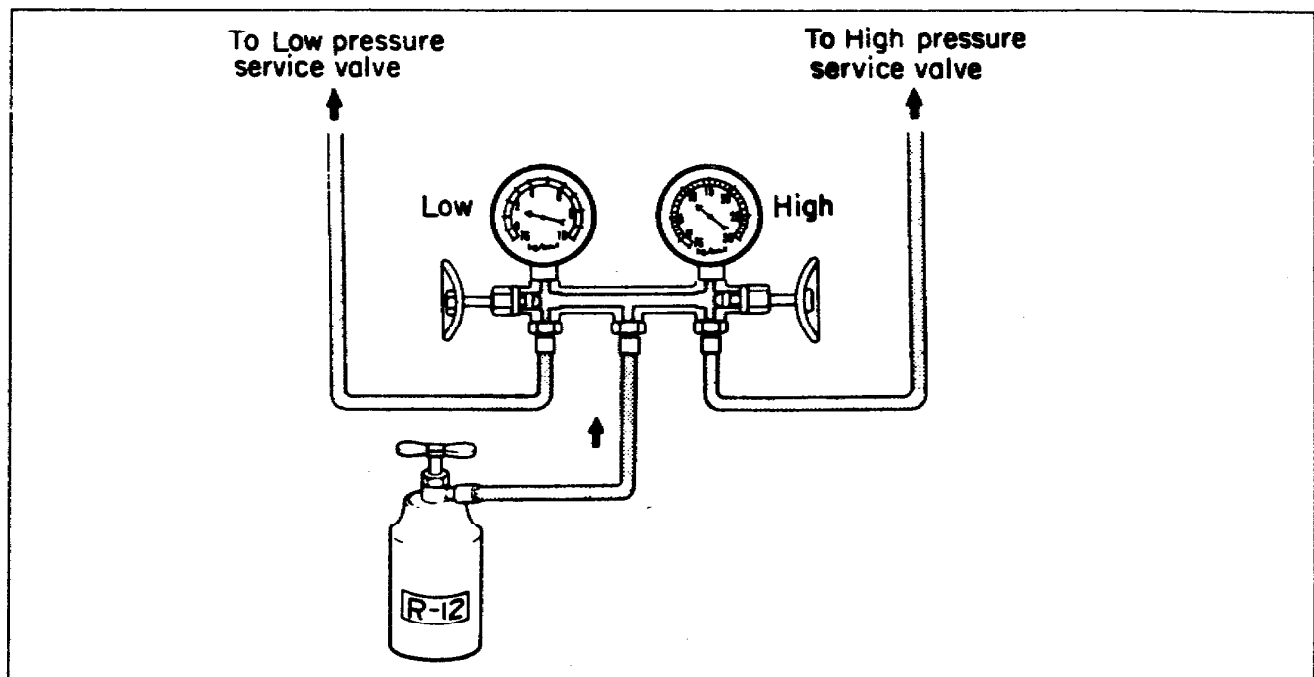
**CAUTION:**

When charging liquefied refrigerant into the system with the can turned upside down to reduce charging time, charge it only through high pressure (discharge) service valve, but not through low pressure (suction) service valve. After completion of charging, the compressor should always be turned several times manually.

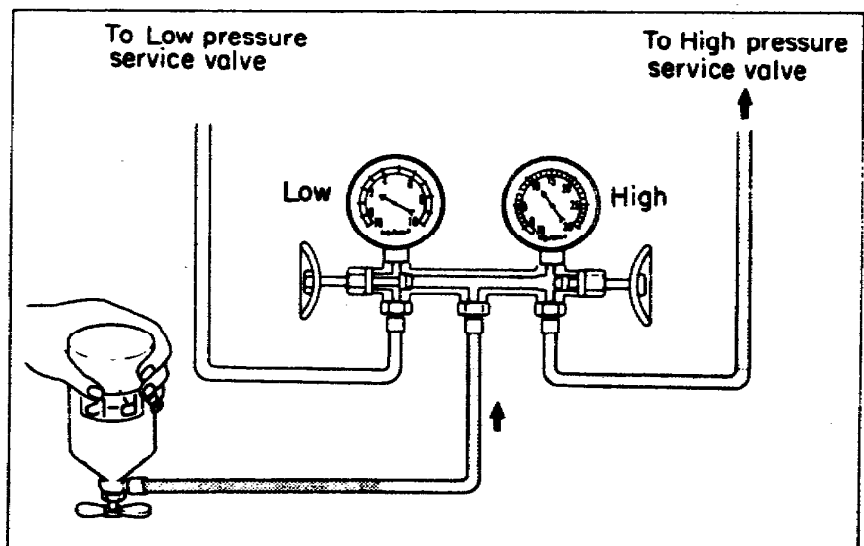

C. EVACUATING AND CHARGING SYSTEM (Cont'd.)

CHARGING REFRIGERANT (Cont'd.)

4. If the refrigerant charging rate slows down before reaching required charge weight, either run the compressor or use an electrically heated charging cylinder to force R-12 into the system. If charging can be done while running the compressor, proceed with charging in the following order.
 1. Shut off the high-pressure valve of the manifold gauge.
 2. Run the compressor.
 3. Set the Temperature control and Fan switch at maximum cool and Evap Fan switch at maximum cool and maximum speed respectively.
 4. Charge refrigerant while controlling low-pressure gauge reading at 40 psi (2.8 kg/cm², 275 kPa) or less by turning the low-pressure valve of the manifold gauge in or out.

WARNING: (COMPRESSOR RUNNING): NEVER CHARGE REFRIGERANT THROUGH HIGH PRESSURE SIDE (DISCHARGE SIDE) OF SYSTEM SINCE THIS WILL FORCE REFRIGERANT BACK INTO REFRIGERANT CAN AND CAN MAY EXPLODE.

5. When the refrigerant can is empty, fully close both valves of the manifold gauge and replace the empty can with a new one.

Before opening the manifold gauge valve to charge refrigerant from a new can, be sure to purge air from inside the charging hose.

6. Charge the system with refrigerant until the sight glass is clear of bubbles. The sight glass is part of the receiver/dryer bottle and it may be remote in the liquid discharge line between the condenser and expansion valve. (See Refrigerant Level Check Section).
7. After the refrigerant has been charged into the system, close the manifold gauge valves.
8. Confirm that there are no leaks in the system by checking with a leak detector.

C. EVACUATING AND CHARGING SYSTEM (cont'd)

CHARGING REFRIGERANT (cont'd)

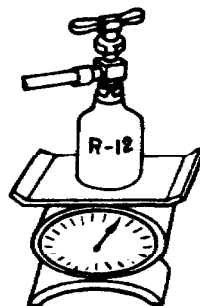
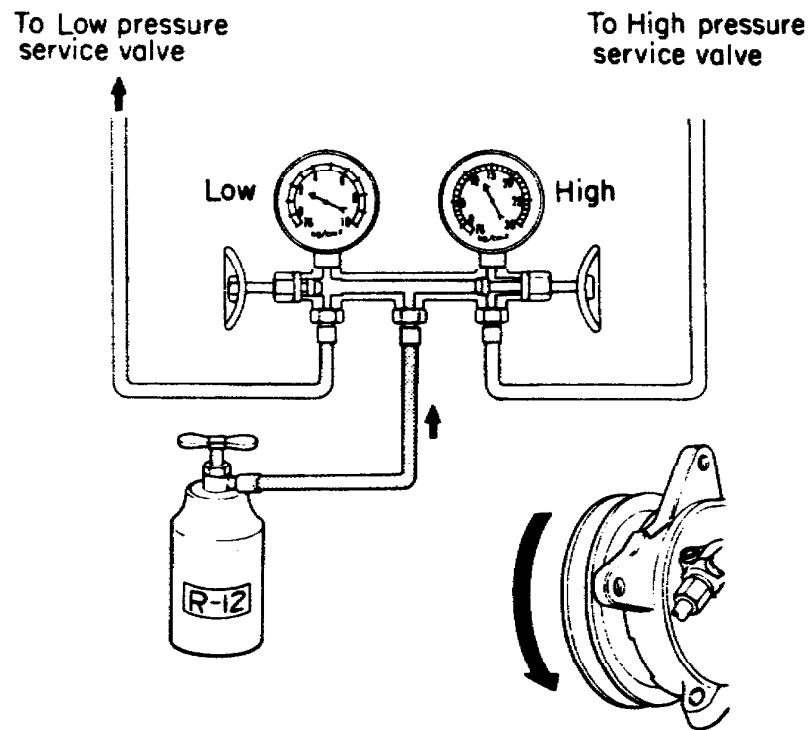

Measure the amount of charged refrigerant with a scale.
Make a note of the amount charged from can.

C. EVACUATING AND CHARGING SYSTEM (cont'd)

REFRIGERANT LEVEL CHECK

1. Set air conditioner switch to "ON" position.
2. Set temperature lever to maximum cold position.
3. Set blower to maximum speed.
4. Check sight glass after the lapse of about five minutes. Judge according to the following table.

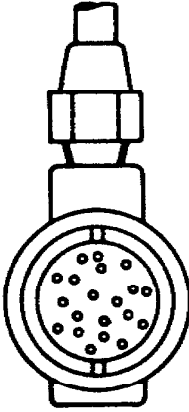
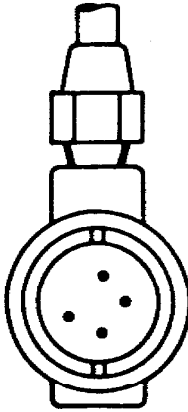
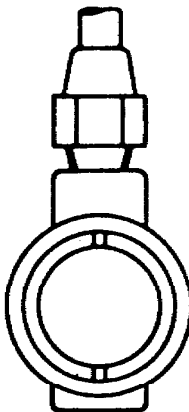
| <div style="text-align: right; padding-right: 5px;">Amount of refrigerant</div> <div style="text-align: left; padding-left: 5px;">Check item</div> | Almost no refrigerant | Insufficient | Suitable | Too much refrigerant |
|--|---|--|--|--|
| Temperature of high pressure and low pressure lines. | Almost no difference between high pressure and low pressure side temperature. | High pressure side is warm and low pressure side is fairly cold. | High pressure side is hot and low pressure side is cold. | High pressure side is abnormally hot. |
| State in sight glass. | Bubbles flow continuously. Bubbles will disappear and something like mist will flow when refrigerant is nearly gone. <div style="text-align: center; margin-top: 10px;">  </div> | The bubbles are seen at intervals of 1 - 2 seconds. <div style="text-align: center; margin-top: 10px;">  </div> | Almost transparent. Bubbles may appear when engine speed is raised and lowered. <p style="text-align: center; margin-top: 10px;">No clear difference exists between these two conditions.</p> <div style="text-align: center; margin-top: 10px;">  </div> | No bubbles can be seen. |
| Pressure of system. | High pressure side is abnormally low. | Both pressure on high and low pressure sides are slightly low. | Both pressures on high and low pressure sides are normal. | Both pressures on high and low pressure sides are abnormally high. |
| Repair. | Stop compressor immediately and conduct an overall check. | Check for gas leakage, repair as required, replenish and charge system. | | Discharge refrigerant from service valve of low pressure side. |

C. EVACUATING AND CHARGING SYSTEM (Cont'd.)

REFRIGERANT LEVEL CHECK (Cont'd.)

5.

- a. The bubbles seen through the sight glass are influenced by the ambient temperature. Since the bubbles are hard to see in comparatively low temperatures below 68° F. (20° C.), it is possible that a slightly larger amount of refrigerant would be filled, if supplied according to the sight glass. Be sure to recheck the amount when it exceeds 68° F. (20° C.). In higher temperature the bubbles are easy to see.
- b. When the screen in the receiver drier is clogged, the bubbles will appear even if the amount of refrigerant is normal. In this case, the outlet side pipe of the receiver drier becomes considerably cold.

REFRIGERANT LEAKS

If leaks are noticeable, leaky parts should be replaced. Then the system should be filled with refrigerant.

CAUTION: DO NOT OPERATE COMPRESSOR WITH REFRIGERANT LEVEL EXCESSIVELY LOW. IF THIS CAUTION IS NEGLECTED, A DAMAGED COMPRESSOR WILL RESULT SINCE HEAVY LOSS OF REFRIGERANT USUALLY INDICATES HEAVY LOSS OF COMPRESSOR OIL.

If system has been open to the atmosphere for an extended period of time, the receiver drier must be replaced. If leaks are slight and no air is present in the system, add refrigerant as necessary.

Checking For Refrigerant Leaks

When checking the system for leaks, the system should be allowed to be operated from 10 to 15 minutes prior to checking.

CAUTION: THE USE OF A FLAME-TYPE LEAK DETECTOR IS NOT RECOMMENDED FOR USE ON AIRCRAFT BECAUSE OF FIRE AND HEALTH HAZARD.

The use of the electronic leak detector General Electric Model H-10 is recommended; however, if the H-10 is not available, leak detector solution conforming to MIL-L-25567 can be used to check each fitting, hose connection, and air conditioning components.

Checking Hoses and Pipes.

Check heater and air conditioner for damaged hoses or pipes due to interference or friction with adjoining parts. If damage is minor, repair those affected hose or pipes. If damage is major and if there is the possibility of encountering holes, replace the affected parts.

Carefully check hoses and pipes, especially those located close to moving parts or sharp edges of panels.

C. EVACUATING AND CHARGING SYSTEM (Cont'd.)

REFRIGERANT LEAKS

Conduct a leak test whenever leakage of refrigerant is suspected and when conducting service operations which are accompanied by disassembly or loosening of connection fittings.

Electric Leak-detector

The leak detector is a delicate device that detects small amounts of halogen. In order to use the device properly, read the manuals put out by each maker and perform the specified maintenance and inspections.

Nominal sensitivity
0.58-0.88 oz/year
(15.25g/year)



General precautions for handling leak detector

1. The probe must be correctly aimed at the point to be checked. Each fitting must be checked around its entire periphery. Refrigerant gas is heavier than air, so the underside of the fitting must also be checked.

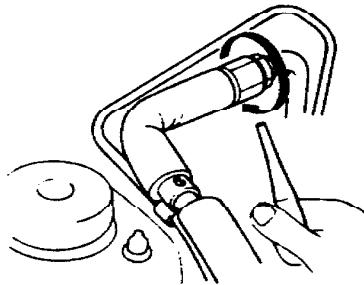

C. EVACUATING AND CHARGING SYSTEM (Cont'd.)

REFRIGERANT LEAKS

2. The probe must be held as close as possible to the checking point, within .12 in (3mm) of the object.

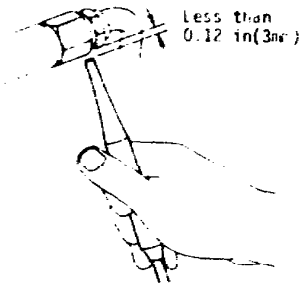

3. The detector requires a certain length of time to react to the gas. The moving speed of the probe must be maintained at less than 1.2 in (3 cm) /sec.

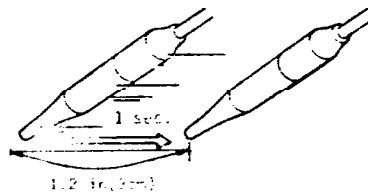

Measurement Standard

If any reaction is noted using a detector having a nominal sensitivity of 0.53 to 0.88 oz (15 to 25 g)/year, that portion checked is considered leaking significantly and therefore must be repaired.

- The nominal sensitivity of the detector is determined under the assumption that all the leaking gas is collected by the detector. Accordingly, the quantity of gas actually leaking can amount to five to ten times the indicated value. Generally speaking, leakage of 5 to 7 oz. (141 to 198g) of refrigerant can cause insufficient cooling.
- Oil deposited during assembling must be wiped off before inspection. Refrigerant easily dissolves in oil, and the presence of oil can cause an error in measurement. This precaution is important when checking a used aircraft for refrigerant leakage.
- If any trace of oil is noted at and around connection fittings, it is a sure indication that refrigerant is leaking.

C. EVACUATING AND CHARGING SYSTEM (Cont'd.)

REFRIGERANT LEAKS (Cont'd.)

Major Check Points

1. Compressor
 - Compressor shaft seal (rotate the compressor by hand).
 - Flexible hose connections.
 - Front and rear head gaskets.
 - Service Valve.
2. Condenser
 - Condenser pipe fitting.
 - Condenser inlet and outlet pipe connections.
3. Refrigerant lines.
 - Line connections.
4. Evaporator housing.
 - Inlet and outlet line connections.
 - Expansion Valve.

If a gas leak is detected, proceed as follows:

1. Check torque on the connection fitting and, if too loose, tighten to the proper torque.
2. If leakage continues even after the fitting has been retightened, discharge refrigerant from system, disconnect the fittings, and check its seating face for damage. Always replace even if damage is slight.
3. Check compressor oil and add oil if required.
4. Charge refrigerant and recheck for gas leaks. If no leaks are found, evacuate and charge system.

D. SERVICE PROCEDURES**GENERAL CLEANING, INSPECTION, AND REPAIR****A. Cleaning**

1. The air conditioning components should be wiped clean with a cloth and a stream of low pressure dry air.

B. Inspection

Every 100 hours inspect the air conditioning system for the following:

1. Security of the mounting.
2. Compressor belt wear and tension.
 - A. After installing a new belt, reset tension again after approximately one hour of operation.
3. Sight gauge for proper refrigerant level.
4. Remove lint and dust from evaporator with vacuum cleaner.
5. At least once a month during the off-season turn the compressor at idle speed for ten minutes.
6. Perform a complete operation and performance test annually at the beginning of the cooling season. See Performance Test in this manual.

C. Repair and Servicing

Field repair is limited to repair of compressor leaks, repair of minor leaks in accessible coil tubes, motor overhaul and repair, and replacement of defective components.

PRECAUTIONS FOR REMOVAL AND INSTALLATION

When replacing refrigerant cycle components, observe the following:

1. Disconnect battery ground cable.
2. Before starting work, be sure to discharge system.

WARNING: GRADUALLY LOOSEN DISCHARGE SIDE HOSE FITTING, AND REMOVE IT AFTER REMAINING PRESSURE HAS BEEN RELEASED.

D. SERVICE PROCEDURES (Cont'd.)

GENERAL CLEANING, INSPECTION, AND REPAIR (Cont'd.)

- After disconnecting tubes, plug all openings immediately to prevent entrance of dirt and moisture.

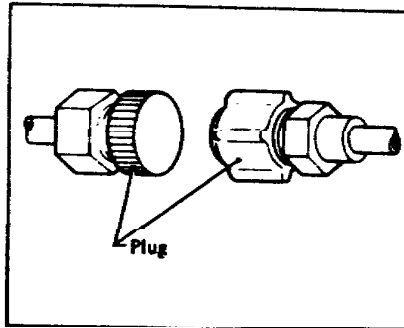

- Compressed air must never be used to clean dirty line. Clean with refrigerant gas.

FLUSH PROCEDURE

Flushing of a system is advisable:

- When replacing a compressor.
- When a system has been contaminated.

Purging with R-12 vapor or other dry vapor under pressure is inadequate cleansing. Only recommended flushing materials should be used. Some satisfactory materials combining refrigerants, such as R-11 as a liquid cleansing agent with R-12 vapor propellant, are available. The following procedure is a method using R-11.

NOTE: When flushing with R-11, do not allow it to enter the compressor.

Step 1 - Disconnect both hose connections to the compressor.

Step 2 - Remove and discard the Receiver-Dryer.

Step 3 - Connect the R-11 container at the discharge hose connection and allow approximately one pound of R-11 to enter the discharge side of the condenser.

Step 4 - Then connect a dry vapor container at that same point, preferably a dry nitrogen with pressure set between 100 and 250 psig. Allow pressurized vapor to enter until all R-11 liquid is purged out the inlet to receiver-dryer hose connection.

Step 5 - Remove expansion valve and clean.

Step 6 - Using the same procedure above, flush and purge the liquid hose from the receiver-dryer to the expansion valve and suction hose and evaporator.

NOTE: Flush tool is useful for inserting the R-11 liquid and dry vapor propellant into the hose connections.

D. SERVICE PROCEDURES (cont'd)

REFRIGERANT LINES

- 1 BARB-LOK 50 hose is designed for use with standard rubber type barbed fittings.

- 2 BARB-LOK 50 cannot be installed with worm gear or any other kind of clamp — you must use the special Parker BARB-LOK socket.

- 3 Cut hose to length keeping end square. Remove any loose fragments.

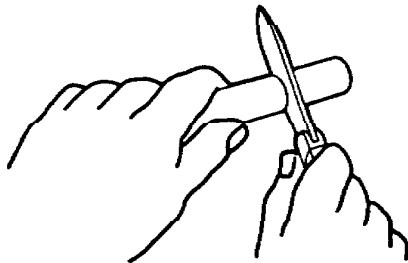

- 4 Slide the BARB-LOK socket onto the fitting, round end towards stop

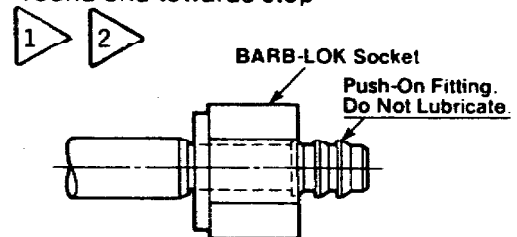

- 5 Push BARB-LOK 50 Hose on barbed end until all barbs are covered. Hose end about 1/8" past last barb

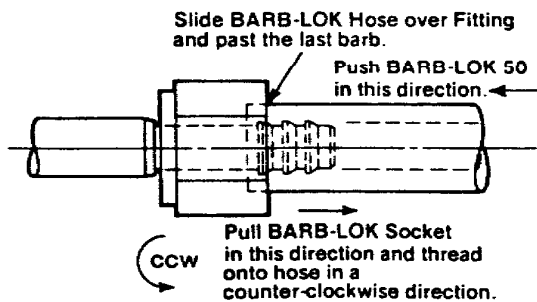

- 6 Hold BARB-LOK 50 Hose in place. Pull socket towards hose and thread onto hose counter-clockwise. Use ratchet or open end wrench to turn socket onto hose. The round end of the socket should be **.82"**, or one socket length from the push-on hose stop.

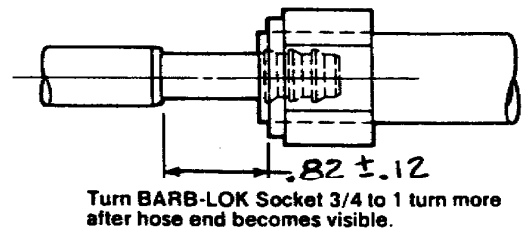

- 7 BARB-LOK 50 hose marking and BARB-LOK 50 sockets are color coded and marked with the correct size. Match socket color with hose layline color.

- 8 After proper assembly with the socket **.82"** from the stop, about 1/8" hose should protrude from the socket. This is indicative of a properly made assembly. This material may be trimmed flush with the socket if desired for improved appearance.

NOTES:

1. Installation of the Barb-lok socket onto the hose is facilitated if the hose is cut to length, then removed and pre-threaded on the bench.
2. To facilitate installation of the nut, first get one thread started and then apply a few drops of light machine oil on the Barb-lok nut and finish the installation.

D. SERVICE PROCEDURES (Cont'd.)

COMPRESSOR

Removal

1. Operate the compressor, if possible, with the air conditioner controls set for maximum cooling and high blower speed for 10 to 15 minutes with all windows open to return the oil to the compressor.
2. Discharge the system. Refer to Discharging System.
3. Disconnect battery ground cable.
4. Loosen the belt tensioning device and remove the compressor drive belt from the compressor pulley. (NOTE: Tension before removal)
5. Disconnect the compressor clutch wire at connector.
6. Remove high and low-pressure hoses from the compressor.

WARNING: GRADUALLY LOOSEN DISCHARGE SIDE HOSE FITTING AND REMOVE IT AFTER REMAINING PRESSURE HAS BEEN RELEASED.

CAUTION: BE SURE TO IMMEDIATELY PUT PLUG IN FLEXIBLE HOSE AND COMPRESSOR OPENINGS.

7. Remove the compressor mounting bolts.
8. Remove the compressor.

Installation

Install in the reverse order of removal, observing the following:

1. Determine the quantity of oil to be charged into the compressor by referring to Compressor Oil Level Check, this Manual.
2. Compressor plugs and flexible hose plugs should be kept in place until preparation for connection is completed.
3. Upon installation of the compressor, turn the compressor clutch by hand a few turns.
4. For reattachment of freon hoses, refer to Barb-Lok 50 Assembly Instructions, this Manual.
5. Provide a clearance of more than 0.4 in. (10mm) between low-pressure hose and high-pressure hose at compressor side.
6. Retension compressor drive belt.
7. Evacuate and recharge the system. Refer to Evacuating System and Charging Refrigerant in this Manual.
8. Conduct a leak test and make sure that there is no leak from any connections.

D. Service Procedures (Cont'd.)

**Pages D-5 through D-10 are
intensionally left blank.**

D. SERVICE PROCEDURES (Cont'd.)**CONDENSER AND EVAPORATOR****Removal**

1. Disconnect battery ground cable.
2. Discharge system. Refer to appropriate section for discharging system.

Inspection

Inspect joints of inlet and outlet pipes for cracks and scratches. Upon finding any problem which may cause gas to leak, repair, or replace condenser.

Coil fins or air passages clogged with dirt, insects or leaves will reduce cooling efficiency of the system. In such a case, clean fins or air passages with compressed air.

Installation

Install condenser or evaporator in the reverse order of removal, observing the following:

1. Keep plugs in place until immediately before connecting work is started.
2. Determine quantity of oil to be charged into the compressor by referring to Compressor Oil Level Check in this Manual.
3. For evacuating and charging the system, refer to the appropriate section.
4. Conduct a leak test and make sure that there is no leak from any connections.

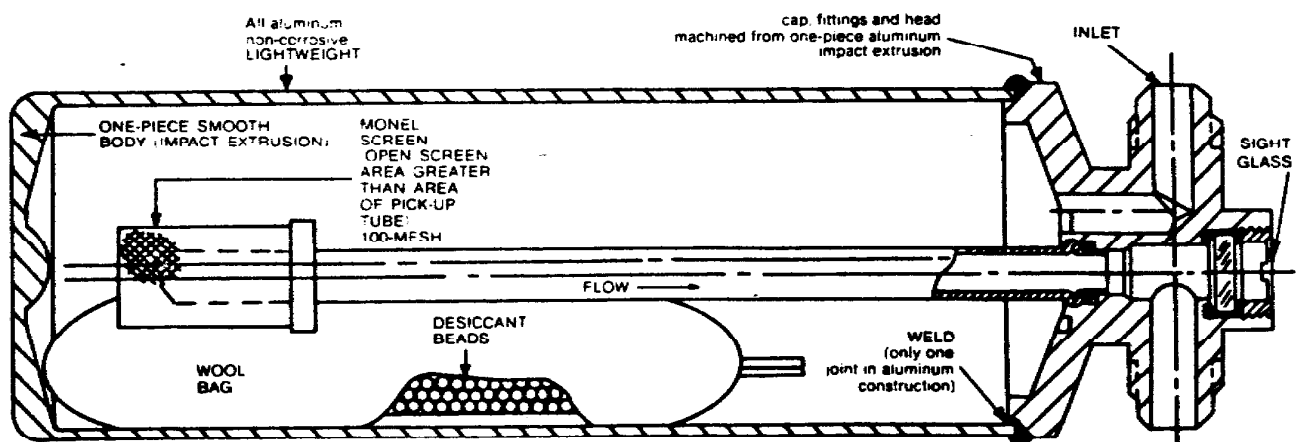
RECEIVER DRYER

ALUMINUM DRYER WITH DESICCANT IN WOOL FELT BAG

D. SERVICE PROCEDURES (Cont'd.)

RECEIVER DRYER (Cont'd.)

Removal and Installation

1. Disconnect the battery ground cable.
2. Discharge the system. Refer to Discharging System in this Manual.
3. Disconnect refrigerant lines from the receiver dryer.

CAUTION: PLUG ALL OPENINGS TO PREVENT ENTRANCE OF DIRT AND MOISTURE

4. Remove the receiver dryer mounting screws. Remove receiver dryer.
5. Install new receiver dryer in the reverse order of removal. With the plugs taken off immediately before connecting work is started, connect the line and the receiver dryer.
6. For evacuating and charging the system, refer to the appropriate sections.
7. Conduct a leak test and make sure that there is no leak from any connections.

Inspection

Check the receiver dryer for leaks or damage. If necessary, replace.

E. TROUBLE DIAGNOSES AND CORRECTIONS

Air Conditioner Diagnoses

The cooling performance characteristics of any air conditioning system are inherent to each system with respect to design parameters such as compressor horsepower, evaporator/condenser size, weight and airflow. The performance of any one system will change with respective changes in evaporator/condenser inlet temperature and humidity. Based on previous or similar systems installed in like aircraft, if the performance is suspected to be unsatisfactory or non-operational, trouble shoot the system. If the discrepancy cannot be diagnosed, conduct the performance Test (Page E-3) recording data indicated and then consult the manufacturer.

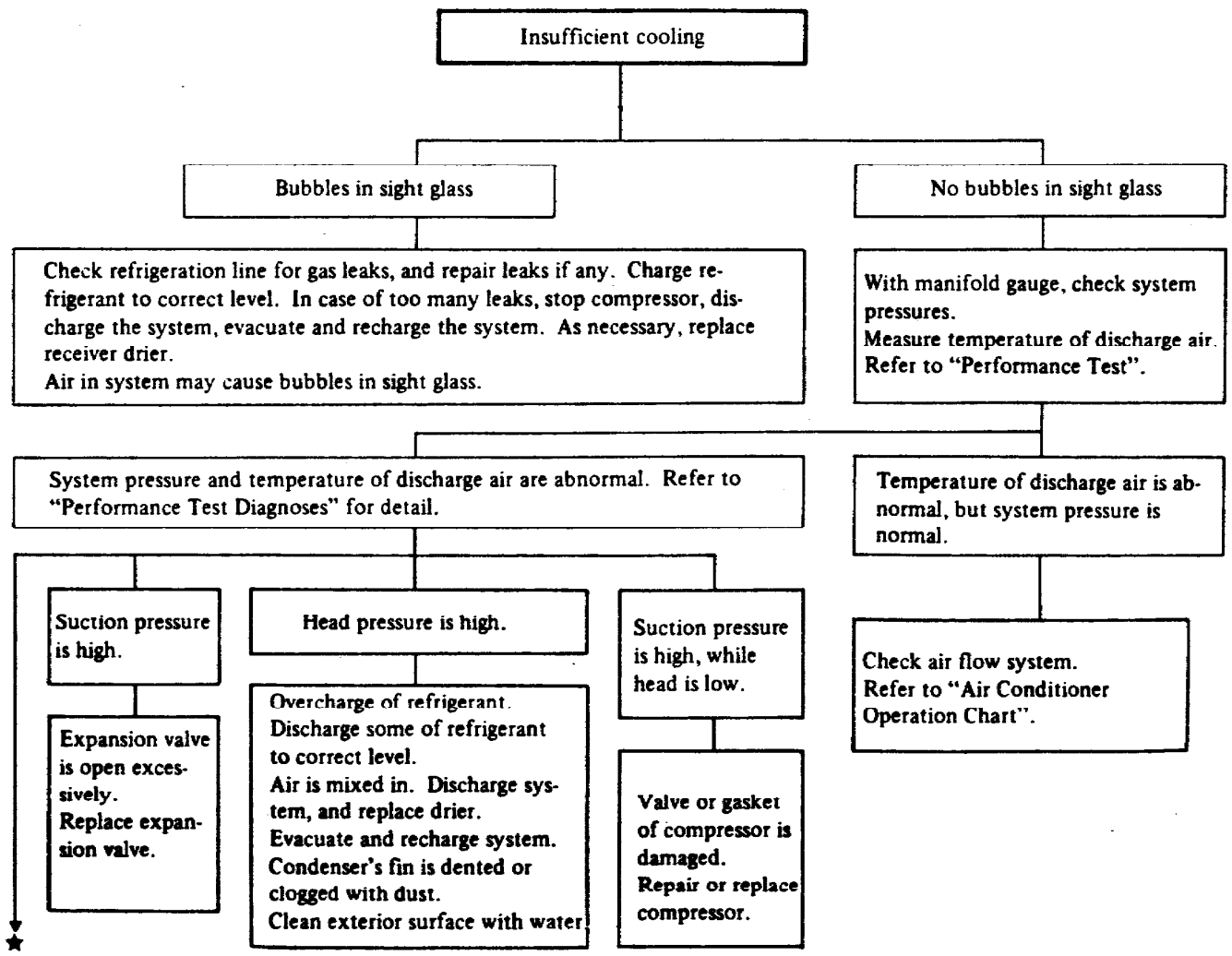

E. TROUBLE DIAGNOSES AND CORRECTIONS (cont'd)

AIR CONDITIONER DIAGNOSES (cont'd)

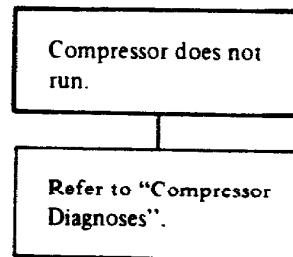
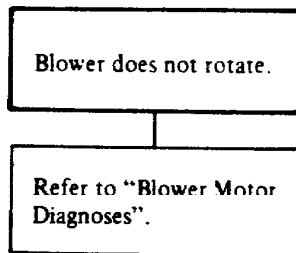
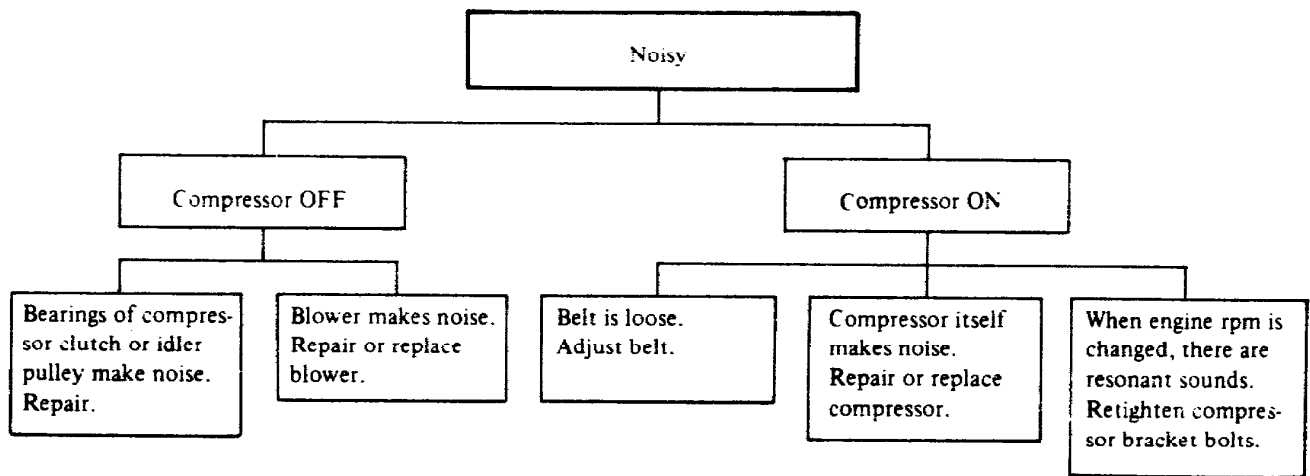
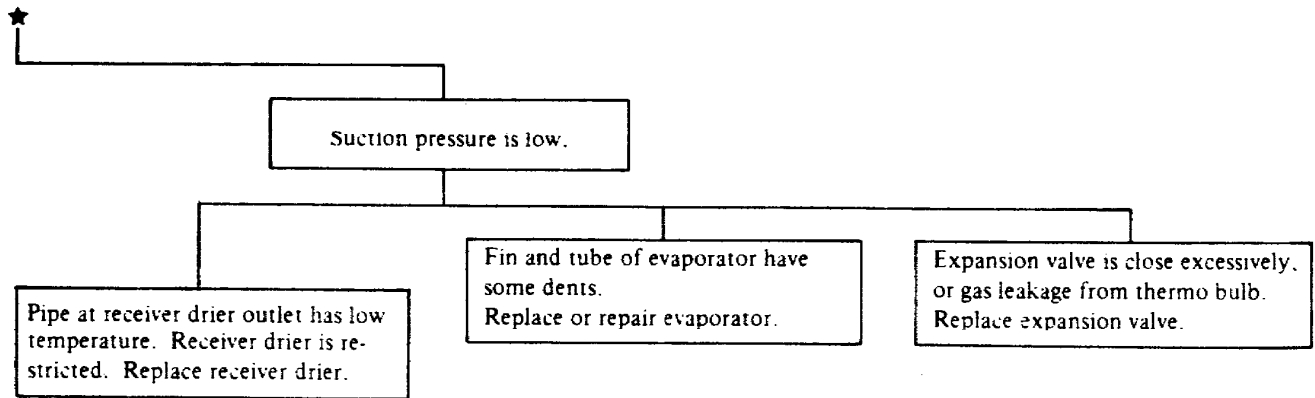

PERFORMANCE TEST DIAGNOSES

Of various conditions caused to the air conditioning system, the characteristics revealed on manifold gauge reading are shown in the following.

As to the method of a performance test, refer to the item of "Performance Test". In the following table, the portion smeared with ink on

each gauge scale indicates a range based on the assumption that the air conditioning system is in good order. This range is described in PERFORMANCE CHART.

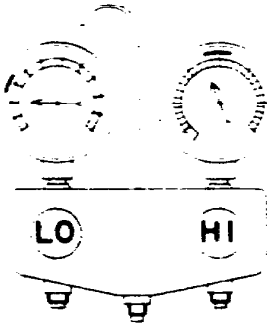
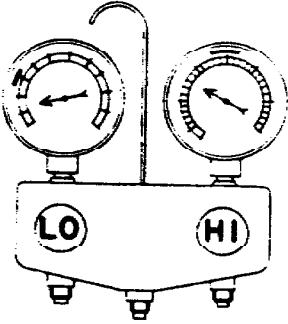
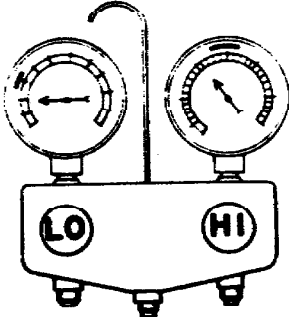
| CONDITION | PROBABLE CAUSE | CORRECTIVE ACTION |
|---|--|--|
| <p>INSUFFICIENT REFRIGERANT CHARGE</p>  | <p>Insufficient cooling. Refrigerant is low, or leaking a little. Bubbles appear in sight glass.</p> | <p>1. Leak test. 2. Repair leak. 3. Charge system. Evacuate as necessary and recharge system.</p> |
| <p>ALMOST NO REFRIGERANT</p>  | <p>No cooling action. Serious refrigerant leak. A lot of bubbles or something like mist appears in sight glass.</p> | <p>Stop compressor immediately. 1. Leak test. 2. Discharge system. 3. Repair leak(s). 4. Replace receiver drier if necessary. 5. Check oil level. 6. Evacuate and recharge system.</p> |
| <p>FAULTY EXPANSION VALVE</p>  | <p>Slight cooling. Expansion valve restricts refrigerant flow. Sweating or frosted expansion valve outlet. Expansion valve is clogged. Expansion valve is inoperative. Valve stuck closed. Thermal bulb has lost charge.</p> | |

E. TRUBLE DIAGNOSES AND CORRECTIONS (cont'd)
 PERFORMANCE TEST DIAGNOSES (cont'd)

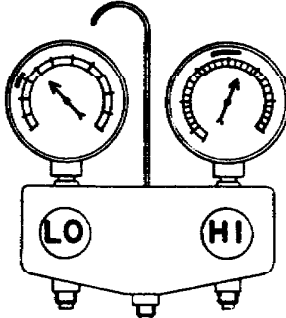
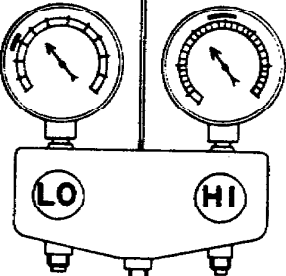
| CONDITION | PROBABLE CAUSE | CORRECTIVE ACTION |
|--|---|---|
|  <p data-bbox="552 556 852 703">Insufficient cooling. Sweated suction line.</p> | <p data-bbox="868 556 1153 682">Expansion valve allows too much refrigerant through evaporator.</p> | <p data-bbox="1177 556 1526 714">Check valve for operation. If suction side does not show a pressure decrease, replace valve.</p> |
|  <p data-bbox="552 945 852 1060">No cooling. Sweating or frosted suction line.</p> | <p data-bbox="868 945 1153 1018">Faulty expansion valve.</p> | <ol data-bbox="1177 945 1526 1071" style="list-style-type: none"> 1. Discharge system. 2. Replace valve. 3. Evacuate and replace system. |

E. TROUBLE DIAGNOSES AND CORRECTIONS (Cont'd.)

PERFORMANCE TEST DIAGNOSES (Cont'd.)

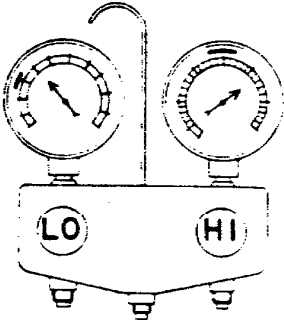
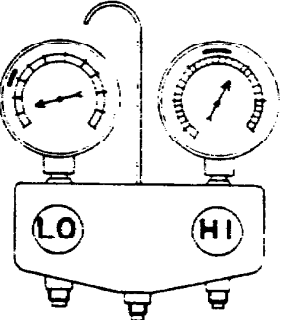
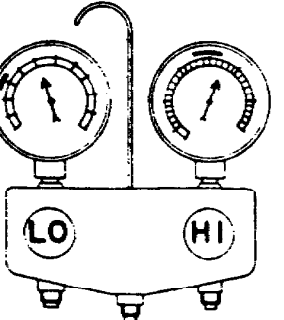
| Condition | Probable cause | Corrective action |
|---|--|--|
| <p>AIR IN SYSTEM</p>  | <p>Insufficient cooling. Sight glass shows occasional bubbles.</p> | <p>Air mixed with refrigerant in system.</p> <ol style="list-style-type: none"> 1. Discharge system. 2. Replace receiver drier. 3. Evacuate and charge system. |
| <p>MOISTURE IN SYSTEM</p>  | <p>After operation for a while, pressure on suction side may show vacuum pressure reading. During this condition, discharge air will be warm. As warning of this, reading shows 39 kPa (0.4 kg/cm², 6 psi) vibration.</p> | <p>Drier is saturated with moisture. Moisture has frozen at expansion valve. Refrigerant flow is restricted.</p> <ol style="list-style-type: none"> 1. Discharge system. 2. Replace receiver drier (twice if necessary). 3. Evacuate system completely. (Repeat 30-minute evacuating three times.) 4. Recharge system. |
| <p>FAULTY CONDENSER</p>  | <p>No cooling action: engine may overheat. Bubbles appear in sight glass of drier. Suction line is very hot.</p> | <p>Condenser is often found not functioning well.</p> <ul style="list-style-type: none"> • Check condenser for dirt accumulation. • Check for refrigerant overcharge. <p>If pressure remains high in spite of all above actions taken, remove and inspect the condenser for possible oil clogging.</p> |

E. TRUBLE DIAGNOSES AND CORRECTIONS (Cont'd.)PERFORMANCE TEST DIAGNOSES (Cont'd.)

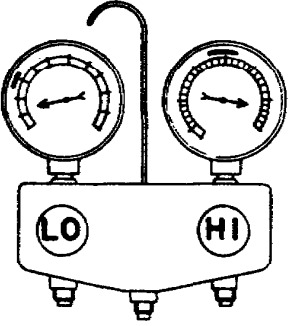
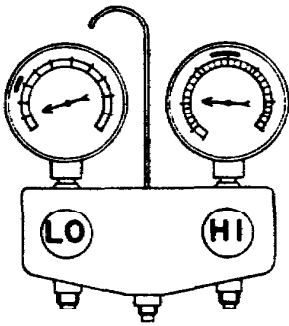
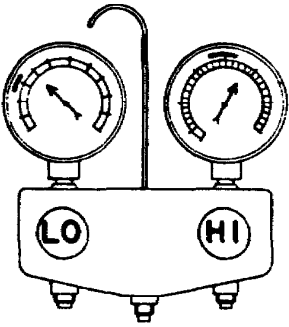
| Condition | Probable cause | Corrective action |
|--|---|---|
| <p data-bbox="198 401 597 436">HIGH PRESSURE LINE BLOCKED</p>  <p data-bbox="565 464 852 556">Insufficient cooling. Frosted high pressure liquid line.</p> | <p data-bbox="873 464 1149 520">Drier clogged, or restriction in high pressure line</p> | <ol data-bbox="1182 464 1458 632" style="list-style-type: none"> 1. Discharge system. 2. Remove receiver drier or strainer and replace it. 3. Evacuate and charge system. |
| <p data-bbox="198 842 488 877">FAULTY COMPRESSOR</p>  <p data-bbox="565 905 776 926">Insufficient cooling.</p> | <p data-bbox="873 905 1149 982">Internal problem in compressor, or damaged gasket and valve.</p> | <ol data-bbox="1182 905 1458 1157" style="list-style-type: none"> 1. Discharge system. 2. Remove and check compressor. 3. Repair or replace compressor. 4. Check oil level. 5. Replace receiver drier. 6. Evacuate and charge system. |
| <p data-bbox="198 1297 446 1354">TOO MUCH OIL IN SYSTEM (Excessive)</p>  <p data-bbox="565 1318 776 1339">Insufficient cooling.</p> | <p data-bbox="873 1318 1149 1423">Too much oil circulates with refrigerant, causing the cooling capacity of the system to be reduced.</p> | <p data-bbox="1182 1318 1458 1367">Refer to Oil Level Check for correcting oil level.</p> |

E. TROUBLE DIAGNOSES AND CORRECTIONS (Cont'd.)

COMPRESSOR / CLUTCH DIAGNOSES

Trouble Shooting Outline

1. Unusual Noise

- A. Clutch disengaged, "chattering": Check air gap.
 - 1. Adjust air gap.
 - 2. Defective clutch pulley or front plate.
- B. Clutch engaged
 - 1. Check compressor mounting components.
 - 2. Check engine components.
 - 3. Check for intermittent or slipping clutch; adjust air gap.
 - 4. Check for proper refrigerant charge; recharge and re-check.
 - 5. Check clutch bearing.
 - 6. Oil level check; restore to proper level.
 - 7. Shaft turning smoothness test.
 - 8. Broken internal parts.

2. Lack of Cooling

- A. Rough running compressor; shaft turning smoothness test.
- B. Intermittent or inoperative
 - 1. Check bolt tension.
 - 2. Check and adjust clutch air gap.
 - 3. Check clutch volts, amps, coil lead wire.
- C. Compressor running but very low suction and discharge pressure
 - 1. Check for low refrigerant charge.
 - 2. Leak check compressor.
 - 3. Leak check and diagnose system (see Air Conditioner Diagnoses).
- D. Compressor running but very high suction pressure and very low discharge pressure
 - 1. Broken head or block gasket.
 - 2. Broken or deformed reed valve.
 - 3. Foreign substance under reed valve or gasket.

Compressor and Clutch Test

Shaft turning smoothness test (Compressor Installed)

- Step 1 - Disconnect refrigerant hoses,
- Step 2 - Disengage clutch.
- Step 3 - Uncap fittings.
- Step 4 - Rotate compressor shaft, using 3/4 inch socket and wrench on shaft nut.
- Step 5 - While rotating, if severe rough spots or "catches" are felt, replace the compressor.

E. TRUBLE DIAGNOSES AND CORRECTIONS (Cont'd.)

COMPRESSOR / CLUTCH DIAGNOSES (Cont'd.)

Clutch Test - 14 vdc (Blk Wire)/28 vdc (Grn. Wire)

Step 1 - Check to see if field coil lead wire is broken.

Step 2 - Check amperage and voltage. The amperage range requirement is 3.6 to 4.2 at 12 volts and 1.5 to 2.0 @ 24 vdc. Note the following symptoms and remedies:

- A very high amperage reading - An open circuit within the field coil.
- No amperage reading - An open circuit in the winding.
- An intermittent or poor system ground results in lower voltage at the clutch. Check for tight fit of coil retaining snap ring or coil retaining screws for good ground. Consult Systems Manual to determine proper system ground.

Step 3 - Air gap - An incorrect air gap could cause erratic engagement or disengagement and/or clutch rattle. Check the air gap with a feeler gauge (.016" - .031"0).

Step 4 - Suspected bearing noise - Do the following:

- Remove belt. Disengage clutch.
- Rotate rotor pulley by hand.
- Listen for bearing noise. Feel for hard spots.

Usual Noise.

Compressor Mounting Components

Check for:

- Loose belt.
- Broken bracket and/or compressor mounting ear, replace broken component.
- Missing, broken or loose bolts at compressor and engine fixing points.
- Flush fit at all points and replace any bracket component not fitting properly. Torque bolts to engine using manufacturer's specifications.
- Loose or wobbling crankshaft pulley, and for center bolt torque and "bottoming". Repair or replace bracket.
- Rough idler pulley bearing. Replace if necessary.

Refrigerant Charge

- A 0-5 psig or lower suction pressure due to a low refrigerant charge can cause unusual noise. Restore refrigerant to proper level.
- Re-test by applying heat to evaporator for higher suction pressure.

Clutch Bearing

- See Clutch Test

Oil Level

- Insufficient oil can cause unusual noise. See Compressor Oil Level Check.

Valve Noise

- Broken or distorted reed valve or broken gasket.

Valve Plate Test

- Valve plate failures (suction or discharge valve or gasket) may be determined with the compressor installed.

E. TROUBLE DIAGNOSES AND CORRECTIONS (Cont'd.)

COMPRESSOR / CLUTCH DIAGNOSES (Cont'd.)

Discharge or Suction Valve Breakage

- When compressor is operated at idling speed, compressor makes a "clacking" sound.

Head Gasket Breakage

- At idling speed, discharge pressure does not increase to normal condition and suction pressure is high.

Checking Method of Discharge Valve and Head Gasket by Pressure Balancing Test

- Step 1 - Connect manifold gauge set to suction and discharge service ports.
- Step 2 - Run compressor for 5 minutes at idling speed and stop.
- Step 3 - Measure elapsed time that discharge pressure is balanced to suction pressure. If less than 2 minutes, it is determined that discharge valve or head gasket is broken.

E-11

THIS PAGE INTENTIONALLY LEFT BLANK.

F. COMPRESSOR OVERHAUL PROCEDURES

GENERAL:

The following procedures apply to rotary compressor assemblies used on the Parker Hannifin air conditioning systems. Consult the factory for specific compressor overhaul kit part numbers. Service will be limited to replacement of compressor, bearing, coil and service valves.

- NOTE -

When replacing compressor body, be sure to transfer all mounting ear bushings to replacement compressor body. Stake all bushings in place on mounting ears.

TOOLS REQUIRED:

Compressor Pulley Puller - obtainable from local auto parts store or use a standard gear puller with locally fabricated bushings or socket combinations.

COMPRESSOR DRIVE TYPES:

Clutched Pulley Compressors

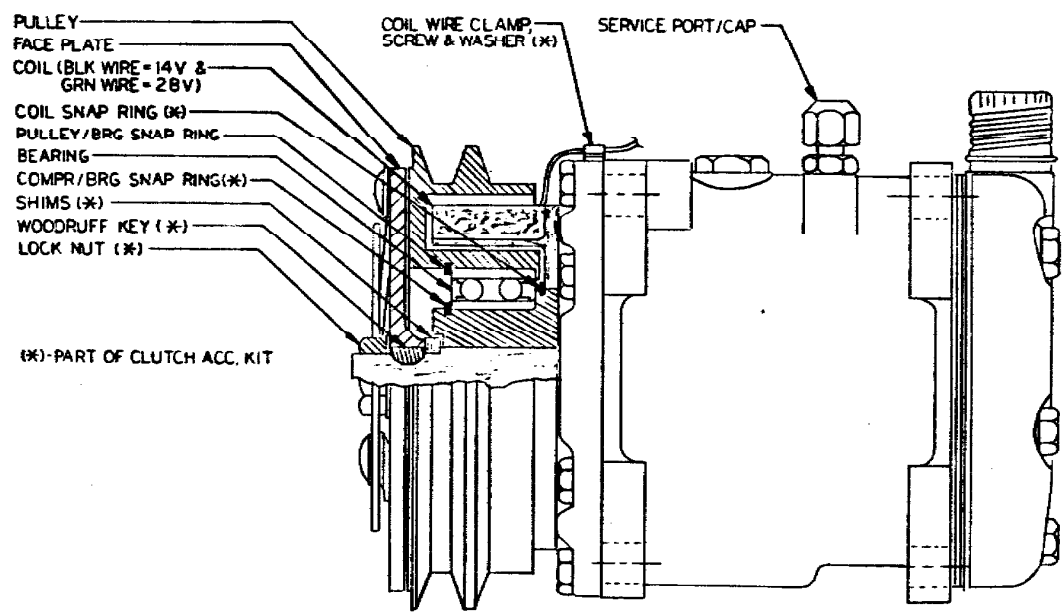

F. COMPRESSOR OVERHAUL PROCEDURES (Cont'd.)

COMPRESSOR DRIVE TYPES (Cont'd.)

Clutched Pulley with Adapter Pulley Compressors

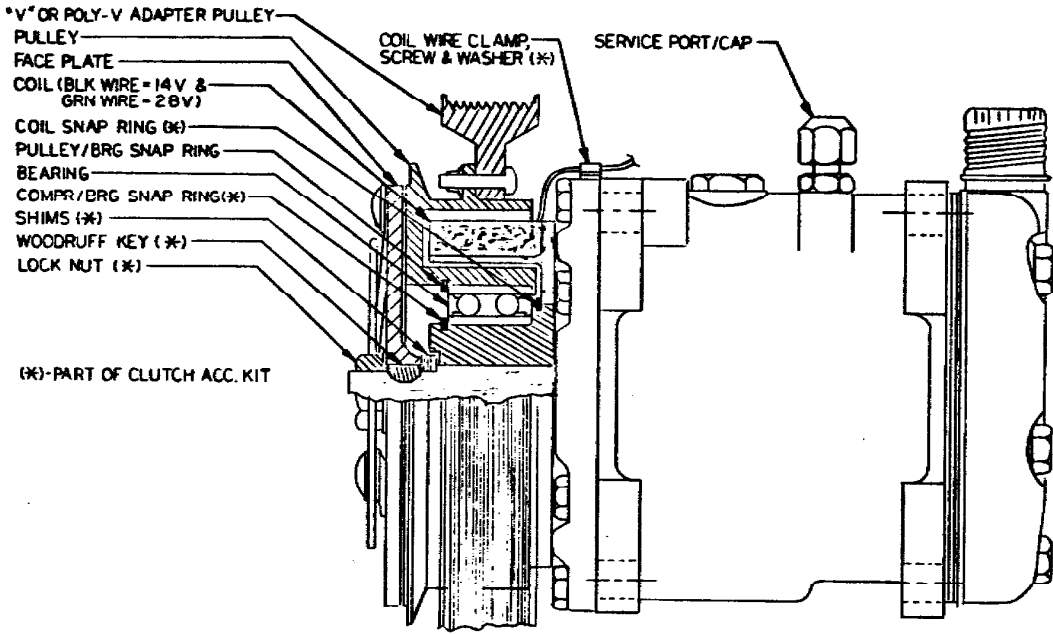

F. COMPRESSOR OVERHAUL PROCEDURES (Cont'd.)

COMPRESSOR DRIVE TYPES (Cont'd.)

Unclutched Compressors

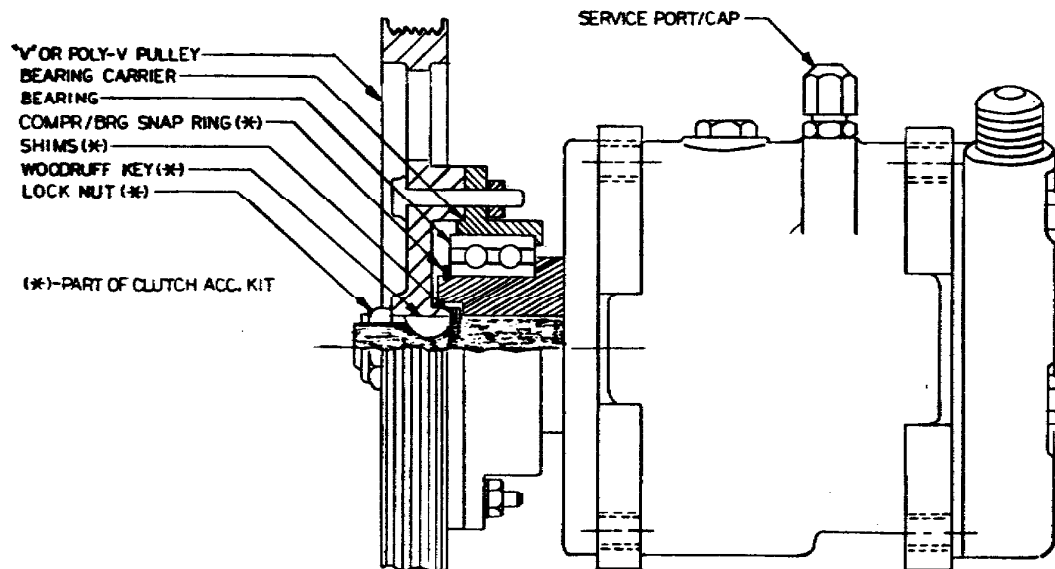

F. COMPRESSOR OVERHAUL PROCEDURES (Cont'd.)

DISASSEMBLY PROCEDURE

General - All service operations are to be performed on the bench. Service operations described below apply to all types of compressor assemblies. Transfer all mounting ear bushings from the old compressor body to the replacement compressor body. Stake bushings in place.

- Step 1 - Insert the two pins of the front plate spanner into any two threaded holes of the clutch front plate. Hold clutch plate or pulley (for unclutched compressors) stationary and remove hex nut. Remove screws and nuts holding large pulley to bearing carrier.
- Step 2 - Remove clutch front plate or pulley (unclutched) using puller.
- Step 3 - Remove Woodruff key by lightly tapping it loose with a slot screw driver and hammer. Remove all shims.
- Step 4 - Remove pulley/bearing snap ring, internal type (clutched compressors) using pinch type snap ring pliers.
- Step 5 - Remove compressor/bearing snap ring, external type (clutched or unclutched compressors) using spread type snap ring pliers.

F. COMPRESSOR OVERHAUL PROCEDURES (Cont'd.)

DISASSEMBLY PROCEDURES (Cont'd.)

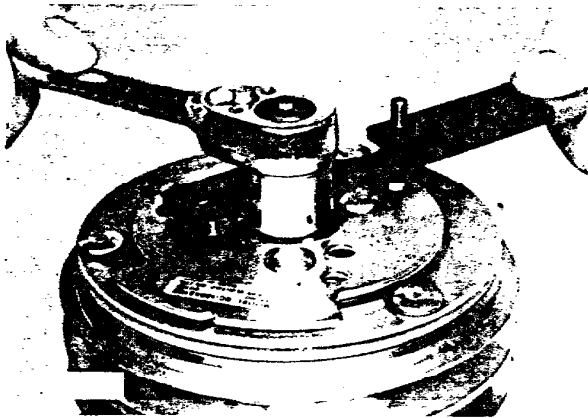

STEP 1

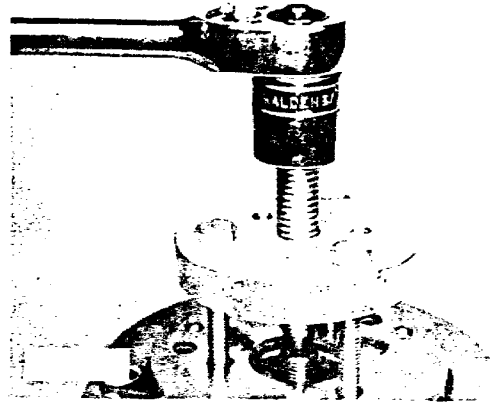

STEP 2

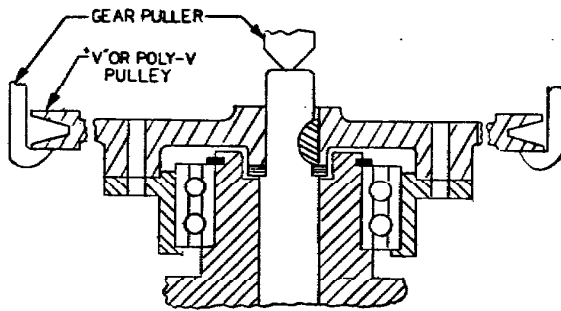

STEP 2

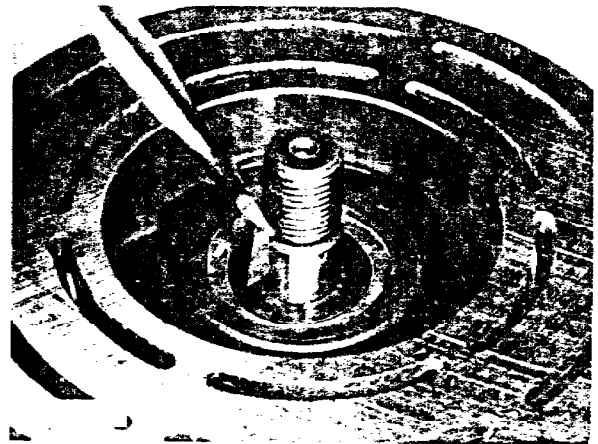

STEP 3

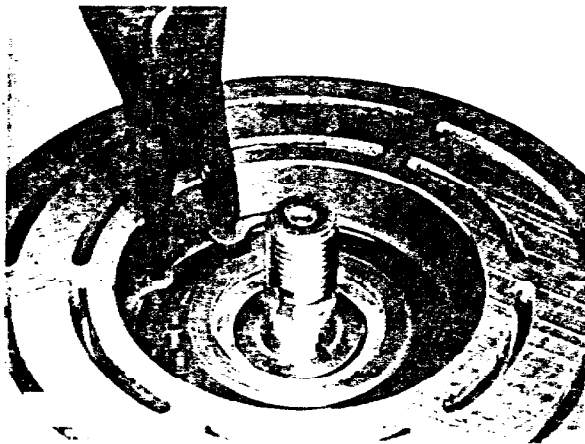

STEP 4

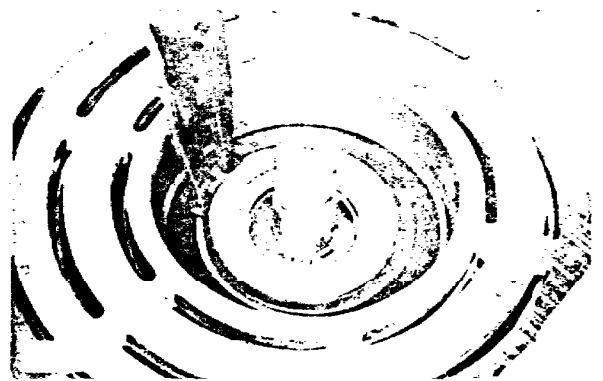

STEP 5

F. COMPRESSOR OVERHAUL PROCEDURES (Cont'd.)

DISASSEMBLY PROCEDURE (Cont'd.)

Step 6 - Remove the rotor pulley assembly as follows (clutched compressors):

- Insert the lip of the jaws into the snap ring groove (snap ring removed in step 4).
- Place rotor puller shaft protector over the exposed shaft.
- Align thumb head bolts to puller jaws and finger tighten.
- Turn puller center bolt clockwise until rotor pulley is free.

Step 7 - Remove bearing carrier and bearing using puller (unclutched compressors).

- CAUTION -

DO NOT PUSH ON CENTER SHAFT WITH GEAR PULLER CENTER POINT. USE A 1.0 INCH SOCKET OR LOCALLY FABRICATED BUSHING, TO LOAD GEAR PULLER CENTER POINT FORCE ONTO THE COMPRESSOR BEARING BOSS ONLY. FAILURE TO DO THIS STEP CORRECTLY WILL INTERNALLY DAMAGE THE COMPRESSOR.

Step 8 - Remove field coil as follows (clutched compressors):

- Loosen coil lead wire from clip on top of compressor front housing.
- Remove coil snap ring (external type) using spread type snap ring pliers and remove coil.

F. COMPRESSOR OVERHAUL PROCEDURES (Cont'd.)

DISASSEMBLY PROCEDURE (Cont'd.)

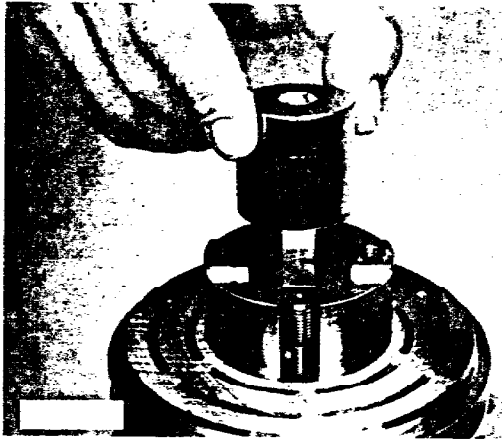

STEP 6

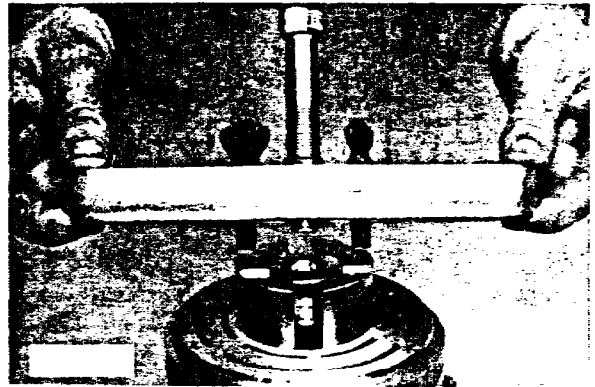

STEP 6

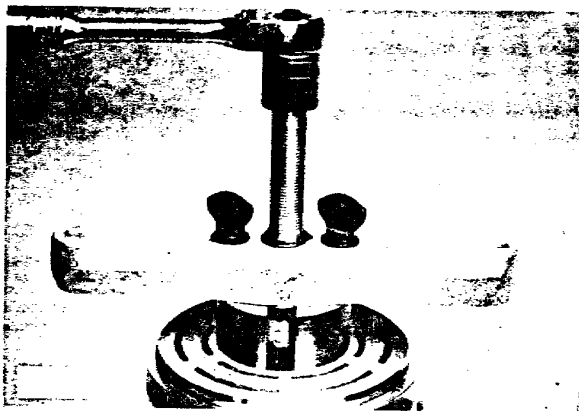

STEP 6

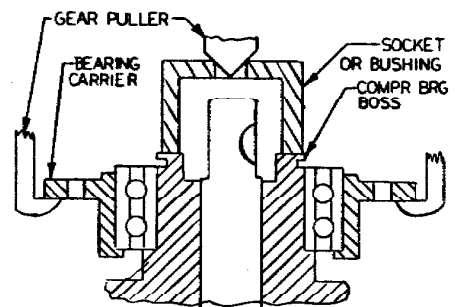

STEP 7

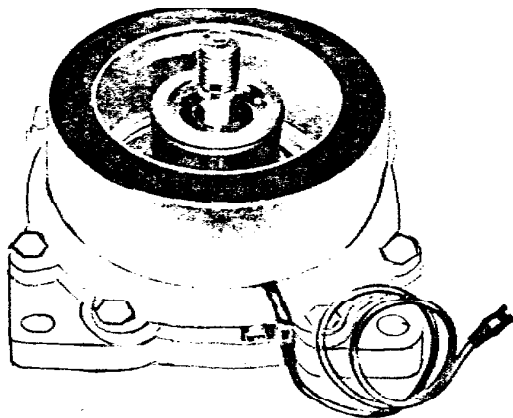

STEP 8

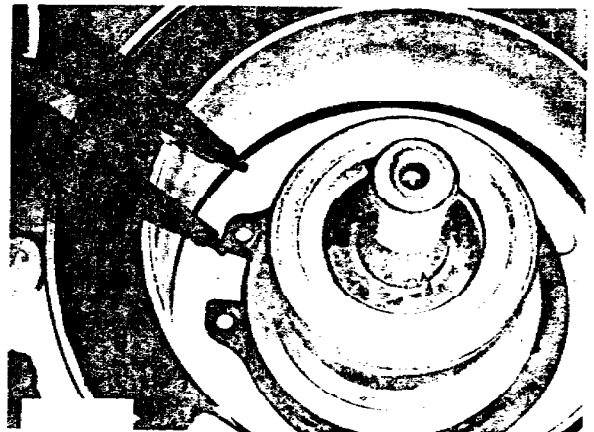

STEP 8

F. COMPRESSOR OVERHAUL PROCEDURES (Cont'd.)

ASSEMBLY PROCEDURE

Step 1 - Install new or replace clutch coil if required (clutched compressors) reversing the procedure outlined in step 7 of disassembly procedures. Retain coil to compressor with large (spread type) snap ring from ES20145 Kit.

- NOTE -

Coil is keyed for proper orientation of lead wire. Position wire with insulator and screw on top of compressor front housing with clip and screw from ES20145 Kit.

Step 2 - Install original or replacement bearing, as required, to bearing carrier (unclutched compressor) or pulley (clutched compressors) using an appropriately sized socket to load force on outer race as shown or load force equally on inner and outer bearing races with a locally fabricated bushing. Replace pulley/bearing snap ring (clutched compressors) removed in step 4 of disassembly procedures.

Step 3 - Replace rotor pulley or bearing carrier with bearing to compressor as follows:

- Support the compressor on the four mounting ears at the rear of the compressor. If using a vice, clamp on the mounting ears only — **NEVER ON THE COMPRESSOR BODY.**
- Align rotor pulley or bearing carrier assembly squarely on the front housing hub.
- Install rotor pulley or bearing carrier assembly onto compressor bearing boss using an appropriately sized socket, locally fabricated bushing or rotor installer set (from Puller Kit) to load force on inner race of bearing only.
- With a hammer, tap the end of the bushing while guiding the assembly to prevent binding. Tap until the bearing bottoms against the compressor front housing bearing boss seat, listening for a distinct change of sound during the tapping process.
- Check pulley or bearing carrier for free rotation.

F. COMPRESSOR OVERHAUL PROCEDURES (Cont'd.)

ASSEMBLY PROCEDURE (Cont'd.)

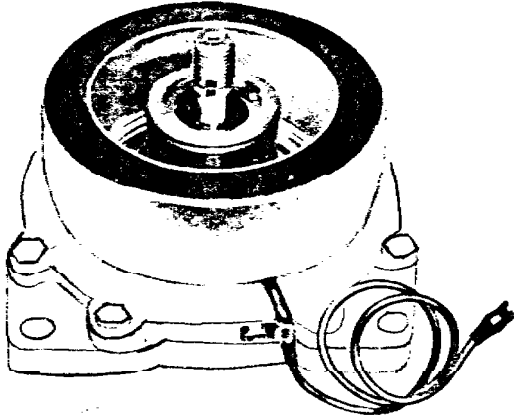

STEP 1

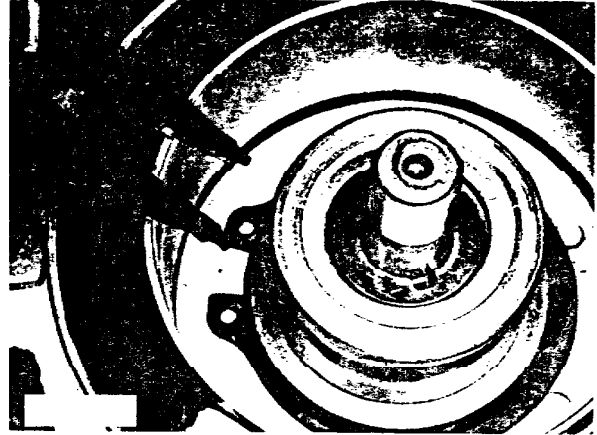

STEP 1

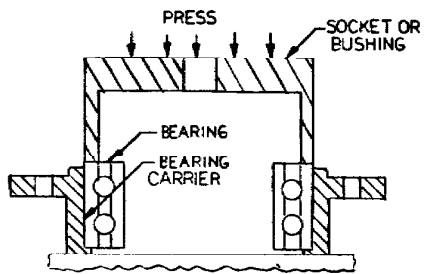

STEP 2



STEP 3

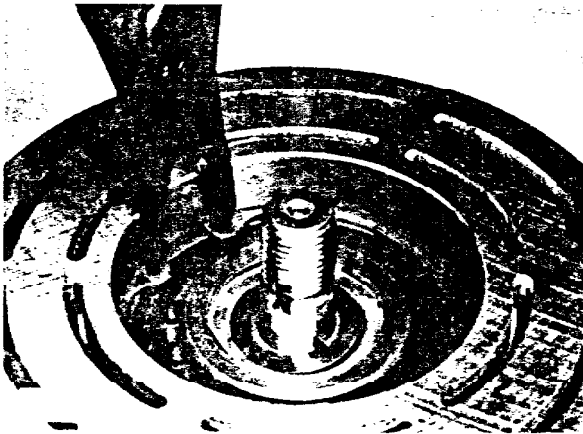

STEP 3

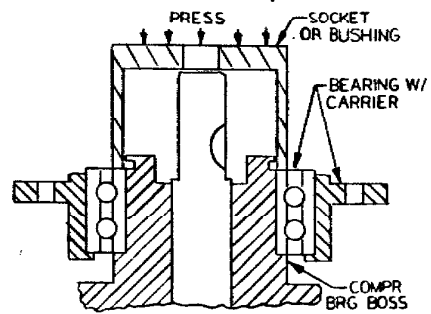

STEP 3

F. COMPRESSOR OVERHAUL PROCEDURES (Cont'd.)**ASSEMBLY PROCEDURE (Cont'd.)**

Step 4 - Install compressor/bearing snap ring, small external type from ES20145 Kit. Beveled side of snap ring must go up - away from compressor body.

Step 5 - Install pulley (unclutched compressors) or face plate (clutched compressors) as follows:

- Install all shims from ES20145 Kit. Stock shims from the thickest to the thinnest and locate stack so that the thickest shim is seated against the drive shaft seat.
- Temporarily install face plate or pulley without key so that boss area is bottomed against shim stack. Maintaining a small load applied to the center boss area of the pulley or face plate, measure the air gap in two places around the circumference and opposite to one another. Take the average of these two values and record.
- Remove face plate and or pulley to gain access to shims. Remove shim stack and install Woodruff key from ES20145 Kit onto drive shaft.
- For Unclutched Compressors - Take the average air gap value recorded earlier and remove that combination of shims plus up to an additional .005 inches from the shim stack. Reinstall shim stack with thickest shim against shaft seat.
EXAMPLE:
If Average Air Gap = .047 inches, remove that combination of shims yielding .047 to .052 inches ($.047 + .005 = .052$) from the shim stack.

- NOTE -

Always remove the thinnest shims first, if possible, so as to reduce the total number of shims in the assembly.

Reattach pulley to bearing carrier with hardware removed in step 1 of the disassembly procedures and replace shaft nut, torque to 25 - 30 ft-lbs.

- For Clutched Compressors - Take the average air gap value recorded earlier and remove that combination of shims to result in a final air gap of .016 to .031 inches between the face plate and pulley.
EXAMPLE:
If Average Air Gap = .070 inches, remove that combination of shims yielding .046 inches ($.070 - .024 = .046$) from the shim stack.

- NOTE -

Always remove the thinnest shims first if possible, so as to reduce the total number of shims in the assemblies.

F. COMPRESSOR OVERHAUL PROCEDURES (Cont'd.)

ASSEMBLY PROCEDURES (Cont'd.)

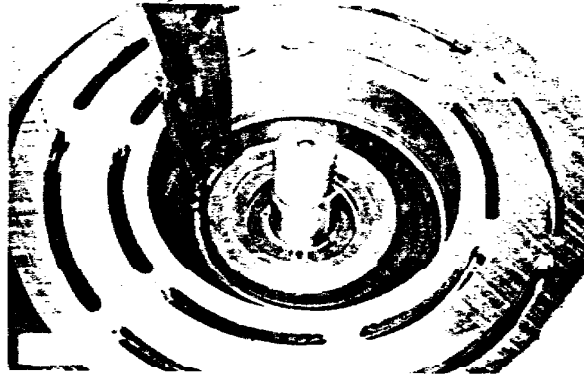

STEP 4

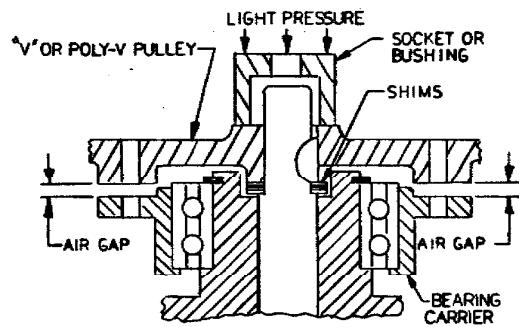

STEP 5

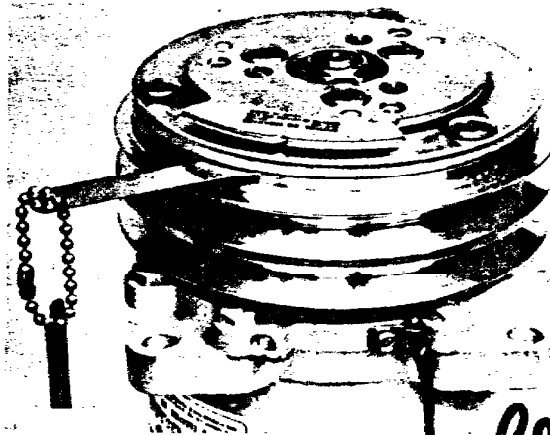

STEP 5

F. COMPRESSOR OVERHAUL PROCEDURES (Cont'd.)

ASSEMBLY PROCEDURES (Cont'd.)

Step 6 - Permanently install face plate (clutched compressors).

- Using appropriately sized socket or locally fabricated bushing tap front plate to shaft until it has bottomed against the shims, noting a distinct sound change.
- Replace shaft hex nut and torque to 25 - 30 ft.-lbs.

Step 7 - Check clutch air gap with feeler gage. Air gap to be .016 to .031 inches and consistent around circumference. Tightly pry up at the minimum variation and tap down at points of maximum variation. If air gap does not meet specifications, add or subtract shims by repeating steps 5 and 6.

Step 8 - Pulley should rotate freely and test for proper clutch operation by applying proper voltage to coil lead wire and ground compressor mounting ear (black coil wire = 14 VDC, 3.5 Amps and green coil wire = 28 VDC, 1.75 Amps). Clutch should snap closed with face plate engaging evenly against pulley.

Step 9 - Check oil level in new compressor as follows:

- NOTE -

All replacement compressors have been preserviced at the factory with 5 ounces of oil.

- Drain and measure the oil from the old compressor.
- Add or subtract oil as required from the new compressor to equal one ounce more than the amount measured in the old compressor.

- NOTE -

Repetitive compressor replacements may cause an excessive buildup of oil in the system. Too much oil can decrease the cooling efficiency. If excessive oil in the system is suspected, perform the Flush Procedure and reestablish the correct system oil level.

F. COMPRESSOR OVERHAUL PROCEDURES (Cont'd.)

ASSEMBLY PROCEDURES (Cont'd.)

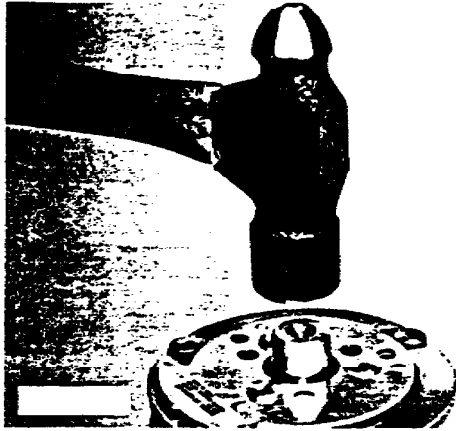

STEP 6

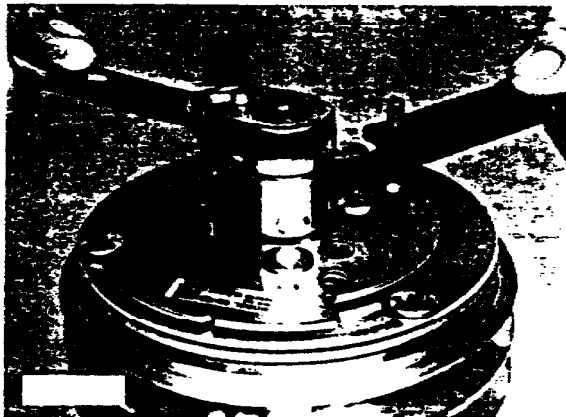

STEP 6

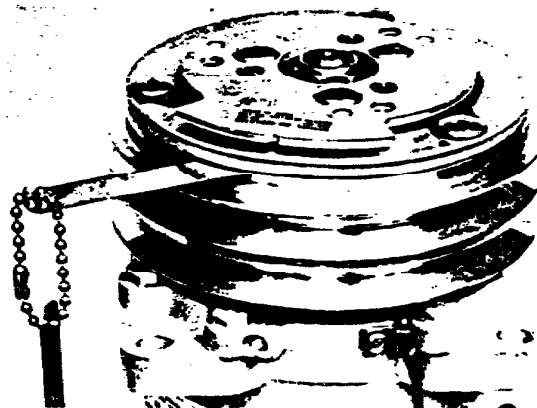

STEP 7